



**PREMIUM SINTERED STONE**

Prodotto Product	Spessori Thickness			Finiture Finishes			
ABSOLUTE	6,5 mm 0.25"	12 mm 0.47"	2 cm 0.78"	Naturale Matt		Levigato Polished	
ALABASTRO	6,5 mm 0.25"	12 mm 0.47"	2 cm 0.78"			Levigato Polished	Honed
ARABESCATO	6,5 mm 0.25"	12 mm 0.47"	2 cm 0.78"	Naturale Matt		Levigato Polished	Honed
ARABESCATO VIOLA	6,5 mm 0.25"	12 mm 0.47"	2 cm 0.78"			Levigato Polished	Honed
AZUL BAHIA	6,5 mm 0.25"	12 mm 0.47"		Naturale Matt		Levigato Polished	
BALLET	6,5 mm 0.25"	12 mm 0.47"	2 cm 0.78"	Naturale Matt		Levigato Polished	
BASALTINA GRIGIA		12 mm 0.47"			Soft Structured		
BASALTINA NERA	6,5 mm 0.25"	12 mm 0.47"			Soft Structured		
BIANCO NAMIBIA	6,5 mm 0.25"	12 mm 0.47"	2 cm 0.78"	Naturale Matt		Levigato Polished	Honed
BLACK DIAMOND	6,5 mm 0.25"	12 mm 0.47"		Naturale Matt		Levigato Polished	
BLACK GOLD	6,5 mm 0.25"	12 mm 0.47"		Naturale Matt		Levigato Polished	
BORGHETTO	6,5 mm 0.25"	12 mm 0.47"	2 cm 0.78"	Naturale Matt		Levigato Polished	Honed
BOULEVARD BLACK		12 mm 0.47"			Soft Structured		
BOULEVARD GREY	6,5 mm 0.25"	12 mm 0.47"			Soft Structured		
BOULEVARD WHITE	6,5 mm 0.25"	12 mm 0.47"			Soft Structured		
BRECCIA REALE	6,5 mm 0.25"	12 mm 0.47"		Naturale Matt		Levigato Polished	Honed
BRECCIA SICILIANA	6,5 mm 0.25"	12 mm 0.47"		ART 5D TECHNOLOGY SURFACE			
BRECCIA STONE BEIGE	6,5 mm 0.25"	12 mm 0.47"		Naturale Matt			Honed
BRECCIA STONE WHITE	6,5 mm 0.25"	12 mm 0.47"		Naturale Matt			Honed
CALACATTA DORATO	6,5 mm 0.25"	12 mm 0.47"	2 cm 0.78"	Naturale Matt		Levigato Polished	Honed
CALACATTA ORO	6,5 mm 0.25"	12 mm 0.47"	2 cm 0.78"	Naturale Matt		Levigato Polished	Honed
CALACATTA VIOLA	6,5 mm 0.25"	12 mm 0.47"	2 cm 0.78"			Levigato Polished	Honed
CALACATTA WHITE	6,5 mm 0.25"	12 mm 0.47"		Naturale Matt		Levigato Polished	
CEMENT ANTHRACITE		12 mm 0.47"			Soft Structured		
COLORADO	6,5 mm 0.25"	12 mm 0.47"				Levigato Polished	Honed
CEMENT WHITE	6,5 mm 0.25"	12 mm 0.47"			Soft Structured		
CEPPO DI GRÈ		12 mm 0.47"			Soft Structured		
CONCRETE ASH	6,5 mm 0.25"	12 mm 0.47"			Soft Structured		
CREMO DELICATO	6,5 mm 0.25"	12 mm 0.47"	2 cm 0.78"	Naturale Matt		Levigato Polished	Honed
EMOTION EUPHORIA	6,5 mm 0.25"	12 mm 0.47"				Levigato Polished	
EMOTION HOPE	6,5 mm 0.25"	12 mm 0.47"				Levigato Polished	
EMOTION WONDER	6,5 mm 0.25"	12 mm 0.47"				Levigato Polished	
FIOR DI BOSCO	6,5 mm 0.25"	12 mm 0.47"		Naturale Matt		Levigato Polished	
GLAM GREEN	6,5 mm 0.25"	12 mm 0.47"				Levigato Polished	
GLAM IVORY	6,5 mm 0.25"	12 mm 0.47"				Levigato Polished	

Prodotto Product	Spessori Thickness			Finiture Finishes			
GOLD CALACATTA	6,5 mm 0.25"	12 mm 0.47"		Naturale Matt		Levigato Polished	
GREAT CALACATTA	6,5 mm 0.25"	12 mm 0.47"		Naturale Matt		Levigato Polished	
GREEN MAJESTIC	6,5 mm 0.25"	12 mm 0.47"				Levigato Polished	Honed
HAMMARVALE		12 mm 0.47"		Naturale Matt			
HEAVEN TRAVERTINO BEIGE	6,5 mm 0.25"	12 mm 0.47"		Naturale Matt		Levigato Polished	Honed
HEAVEN TRAVERTINO TAUPE	6,5 mm 0.25"	12 mm 0.47"		Naturale Matt		Levigato Polished	Honed
HEAVEN TRAVERTINO TIGER	6,5 mm 0.25"	12 mm 0.47"		Naturale Matt		Levigato Polished	Honed
HEAVEN TRAVERTINO WHITE	6,5 mm 0.25"	12 mm 0.47"		Naturale Matt		Levigato Polished	Honed
HERMON	6,5 mm 0.25"	12 mm 0.47"		Naturale Matt		Levigato Polished	
IVORY ONYX	6,5 mm 0.25"	12 mm 0.47"		Naturale Matt		Levigato Polished	
JADE	6,5 mm 0.25"	12 mm 0.47"				Levigato Polished	Honed
LASA WHITE	6,5 mm 0.25"	12 mm 0.47"	2 cm 0.78"	Naturale Matt		Levigato Polished	Honed
LIGHT RED CALACATTA	6,5 mm 0.25"	12 mm 0.47"	2 cm 0.78"	Naturale Matt		Levigato Polished	Honed
MACCHIA VECCHIA AZZURRA	6,5 mm 0.25"	12 mm 0.47"		Naturale Matt		Levigato Polished	
MARCAUBAS BEIGE	6,5 mm 0.25"	12 mm 0.47"	2 cm 0.78"	Naturale Matt	ART 5D TECHNOLOGY SURFACE		
MARCAUBAS IVORY	6,5 mm 0.25"	12 mm 0.47"	2 cm 0.78"	Naturale Matt	ART 5D TECHNOLOGY SURFACE		
MARCAUBAS WHITE	6,5 mm 0.25"	12 mm 0.47"	2 cm 0.78"	Naturale Matt	ART 5D TECHNOLOGY SURFACE		
MARMO ANTICO	6,5 mm 0.25"	12 mm 0.47"	2 cm 0.78"	Naturale Matt		Levigato Polished	Honed
MASADA		12 mm 0.47"		Naturale Matt			
MERAKI	6,5 mm 0.25"	12 mm 0.47"	2 cm 0.78"	Naturale Matt		Levigato Polished	
MONET	6,5 mm 0.25"	12 mm 0.47"		Naturale Matt		Levigato Polished	Honed
MONTE BIANCO	6,5 mm 0.25"	12 mm 0.47"	2 cm 0.78"	Naturale Matt		Levigato Polished	
NAVONA CLASSICO	6,5 mm 0.25"	12 mm 0.47"		Naturale Matt			Honed
NERO MARQUINA	6,5 mm 0.25"	12 mm 0.47"		Naturale Matt		Levigato Polished	
ONICE COBALTO	6,5 mm 0.25"	12 mm 0.47"				Levigato Polished	
ONICE NERO	6,5 mm 0.25"	12 mm 0.47"				Levigato Polished	
ONICE SMERALDO	6,5 mm 0.25"	12 mm 0.47"				Levigato Polished	
ORANGE SAPPHIRE	6,5 mm 0.25"	12 mm 0.47"				Levigato Polished	
OROBICO	6,5 mm 0.25"	12 mm 0.47"		Naturale Matt		Levigato Polished	Honed
PAONAZZETTO REALE	6,5 mm 0.25"	12 mm 0.47"	2 cm 0.78"	Naturale Matt		Levigato Polished	Honed
PIETRA BROWN		12 mm 0.47"		Naturale Matt		Levigato Polished	
PIETRA GRIGIA	6,5 mm 0.25"	12 mm 0.47"		Naturale Matt		Levigato Polished	
PORTORO	6,5 mm 0.25"	12 mm 0.47"		Naturale Matt		Levigato Polished	
PRECIOUS STONE		12 mm 0.47"	2 cm 0.78"	Naturale Matt		Levigato Polished	
SAHARA GREY	6,5 mm 0.25"	12 mm 0.47"		Naturale Matt		Levigato Polished	
PIETRA GRIGIA LIGHT	6,5 mm 0.25"	12 mm 0.47"		Naturale Matt		Levigato Polished	

Prodotto Product	Spessori Thickness			Finiture Finishes			
SAHARA NOIR	6,5 mm 0.25"	12 mm 0.47"		Naturale Matt		Levigato Polished	
SHAPE	6,5 mm 0.25"	12 mm 0.47"		Naturale Matt		Levigato Polished	
STATUARIETTO LIGHT	6,5 mm 0.25"	12 mm 0.47"		Naturale Matt		Levigato Polished	
STATUARIO	6,5 mm 0.25"	12 mm 0.47"		Naturale Matt		Levigato Polished	
STATUARIO IMPERIALE LIGHT	6,5 mm 0.25"	12 mm 0.47"		Naturale Matt		Levigato Polished	Honed
STATUARIO LEONARDO	6,5 mm 0.25"	12 mm 0.47"	2 cm 0.78"	Naturale Matt		Levigato Polished	Honed
STATUARIO RAFFAELLO		12 mm 0.47"	2 cm 0.78"	Naturale Matt		Levigato Polished	
SUPERWHITE	6,5 mm 0.25"	12 mm 0.47"		Naturale Matt		Levigato Polished	
TAJ MAHAL	6,5 mm 0.25"	12 mm 0.47"	2 cm 0.78"	Naturale Matt		Levigato Polished	
TINTA UNITA BIANCO	6,5 mm 0.25"	12 mm 0.47"	2 cm 0.78"	Naturale Matt		Levigato Polished	
TINTA UNITA NERO	6,5 mm 0.25"	12 mm 0.47"		Naturale Matt			
TRAVERTINO WHITE	6,5 mm 0.25"	12 mm 0.47"	2 cm 0.78"	Naturale Matt		Levigato Polished	
WAVE	6,5 mm 0.25"	12 mm 0.47"		Naturale Matt		Levigato Polished	
WOOD ESSENCE ALMOND	6,5 mm 0.25"	12 mm 0.47"		Naturale Matt	Stripes Matt		
WOOD ESSENCE NUT	6,5 mm 0.25"	12 mm 0.47"		Naturale Matt	Stripes Matt		
WOOD ESSENCE OAK	6,5 mm 0.25"	12 mm 0.47"		Naturale Matt	Stripes Matt		

Prodotto Product	Spessori Thickness			Finiture Finishes			
ABSOLUT BLACK STRUCTURED	6,5 mm 0.25"	12 mm 0.47"	2 cm 0.78"	Structured			
ABSOLUT WHITE STRUCTURED	6,5 mm 0.25"	12 mm 0.47"	2 cm 0.78"	Structured			
ARENARIA STONE BEIGE		12 mm 0.47"	2 cm 0.78"	Structured	Leather	Soft Structured	
ARENARIA STONE IVORY		12 mm 0.47"	2 cm 0.78"	Structured	Leather	Soft Structured	
JURA BEIGE		12 mm 0.47"	2 cm 0.78"	Structured	Leather	Soft Structured	
LECCESE STONE BEIGE		12 mm 0.47"	2 cm 0.78"	Structured	Leather	Soft Structured	
LECCESE STONE IVORY		12 mm 0.47"	2 cm 0.78"	Structured	Leather	Soft Structured	
LIMESTONE BEIGE		12 mm 0.47"	2 cm 0.78"	Structured	Leather	Soft Structured	
LIMESTONE IVORY		12 mm 0.47"	2 cm 0.78"	Structured	Leather	Soft Structured	
NORWEGIAN STONE BEIGE		12 mm 0.47"	2 cm 0.78"	Structured	Leather	Soft Structured	
NORWEGIAN STONE GREY		12 mm 0.47"	2 cm 0.78"	Structured	Leather	Soft Structured	
PIERRE PARISIENNE GREIGE		12 mm 0.47"	2 cm 0.78"	Structured	Leather	Soft Structured	
STRUCTURED MARBLE		12 mm 0.47"	2 cm 0.78"	Structured			
TRAVERTINO STONE BEIGE		12 mm 0.47"	2 cm 0.78"	Structured	Leather	Soft Structured	
TRAVERTINO STONE WHITE		12 mm 0.47"	2 cm 0.78"	Structured	Leather	Soft Structured	

[www.nuovocorso.sg](http://www.nuovocorso.sg)

**NUOVOCORSO  
SINTERED STONE**

## **ABSOLUTE**

Suitable for Kitchen Countertops,  
Backsplashes, Dining Tables,  
Vanities, Feature Walls,  
Bathrooms, Floors and the  
Ventilated Facades.

  
**BIGSLABS**®  
BY  
nuovocorso  
Made in Italy

PREMIUM SINTERED  
STONE MANUFACTURER





# ABSOLUTE

## SINTERED STONE

### FORMATO / SIZE



**162x324 cm** 64"x127"  
full size (12 mm / 2 cm)

**160x320 cm** 63"x126"  
Rett. Rect. (6,5 mm)

### SPESSORI / THICKNESSES



**6,5 mm** 0.25"  
**12 mm** 0.47"  
**2 cm** 0.78"

### FINITURE / FINISHES



**Naturale Matt**  
**Levigato Polished**

Stuoia disponibile, a pagamento, su richiesta.  
Fiber available upon request, with surcharge.

  
**BIGSLABS**<sup>®</sup>  
BY  
**nuovocorso**  
Made in Italy

PREMIUM SINTERED  
STONE MANUFACTURER

[www.nuovocorso.sg](http://www.nuovocorso.sg)

**NUOVOCORSO  
SINTERED STONE**

## **ALABASTRO**

Suitable for Kitchen Countertops,  
Backsplashes, Dining Tables,  
Vanities, Feature Walls,  
Bathrooms, Floors and the  
Ventilated Facades.

  
**BIGSLABS**®  
BY  
nuovocorso  
Made in Italy

PREMIUM SINTERED  
STONE MANUFACTURER

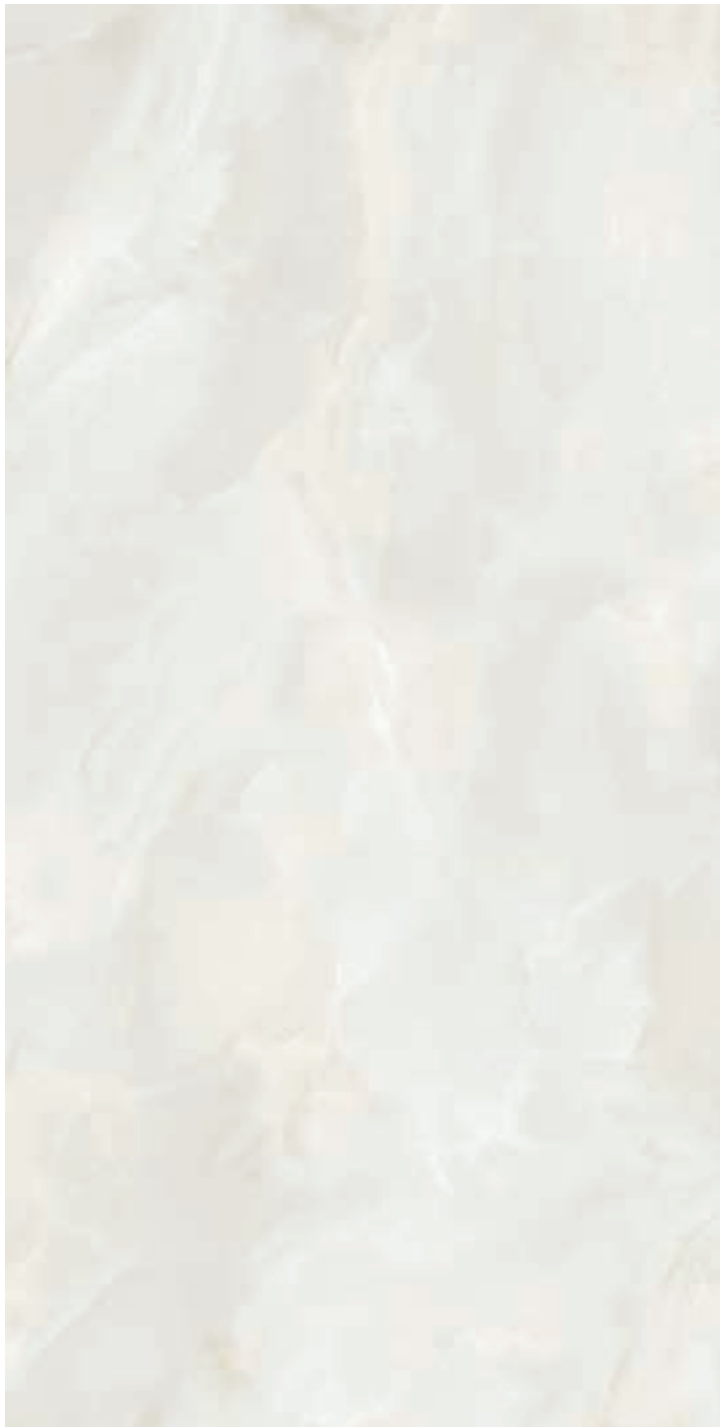

# ALABASTRO

## SINTERED STONE

### FORMATO / SIZE



**162x324 cm** 64"x127"  
full size (12 mm / 2 cm)

**160x320 cm** 63"x126"  
**Rett.** Rect. (6,5 mm)

### SPESSORI / THICKNESSES



**6,5 mm** 0.25"  
**12 mm** 0.47"  
**2 cm** 0.78"

### FINITURE / FINISHES



**Levigato** Polished  
**Honed** Honed

Stuoia disponibile, a pagamento, su richiesta.  
Fiber available upon request, with surcharge.

  
**BIGSLABS**<sup>®</sup>  
BY  
**.nuovocorso**  
Made in Italy

PREMIUM SINTERED  
STONE MANUFACTURER

[www.nuovocorso.sg](http://www.nuovocorso.sg)

**NUOVOCORSO  
SINTERED STONE**

## **ARABESCATO**

Suitable for Kitchen Countertops,  
Backsplashes, Dining Tables,  
Vanities, Feature Walls,  
Bathrooms, Floors and the  
Ventilated Facades.

  
**BIGSLABS**®  
BY  
nuovocorso  
Made in Italy

PREMIUM SINTERED  
STONE MANUFACTURER



# ARABESCATO

## SINTERED STONE

### FORMATO / SIZE



**162x324 cm** 64"x127"  
full size (12 mm / 2 cm)

**160x320 cm** 63"x126"  
Rett. Rect. (6,5 mm)

### SPESSORI / THICKNESSES



**6,5 mm** 0.25"  
**12 mm** 0.47"  
**2 cm** 0.78"

### FINITURE / FINISHES



**Naturale** Matt  
**Levigato** Polished  
**Honed** Honed

Stuoia disponibile, a pagamento, su richiesta.  
Fiber available upon request, with surcharge.

  
**BIGSLABS**<sup>®</sup>  
BY  
**nuovocorso**  
Made in Italy

PREMIUM SINTERED  
STONE MANUFACTURER

[www.nuovocorso.sg](http://www.nuovocorso.sg)

**NUOVOCORSO  
SINTERED STONE**

## **ARABESCATO VIOLA**

Suitable for Kitchen Countertops,  
Backsplashes, Dining Tables,  
Vanities, Feature Walls,  
Bathrooms, Floors and the  
Ventilated Facades.

  
**BIGSLABS**®  
BY  
nuovocorso  
Made in Italy

PREMIUM SINTERED  
STONE MANUFACTURER



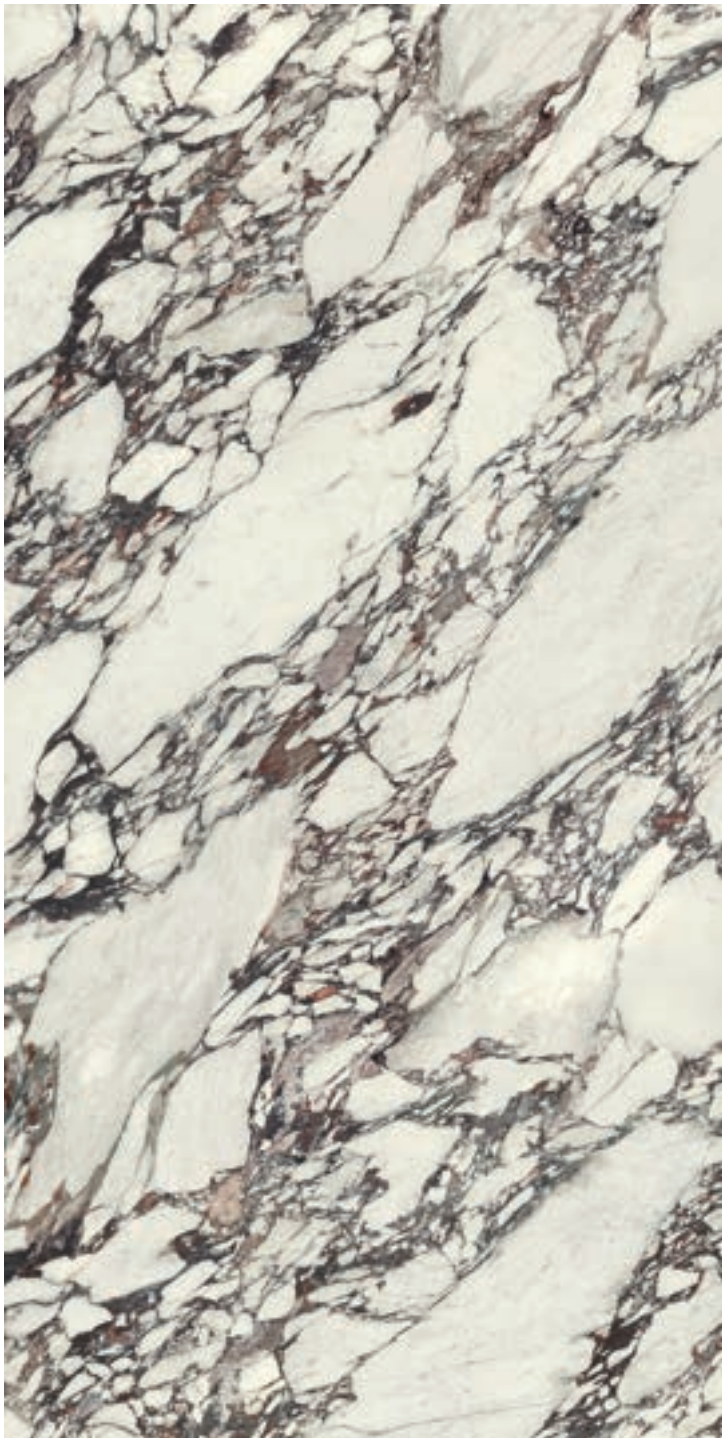

# ARABESCATO VIOLA

SINTERED STONE

## FORMATO / SIZE



**162x324 cm** 64"x127"  
full size (12 mm / 2 cm)

**160x320 cm** 63"x126"  
Rett. Rect. (6,5 mm)

## SPESSORI / THICKNESSES



**6,5 mm** 0.25"  
**12 mm** 0.47"  
**2 cm** 0.78"

## FINITURE / FINISHES



**Levigato** Polished  
**Honed** Honed

Stuoia disponibile, a pagamento, su richiesta.  
Fiber available upon request, with surcharge.

  
**BIGSLABS**®  
BY  
**nuovocorso**  
Made in Italy

PREMIUM SINTERED  
STONE MANUFACTURER

[www.nuovocorso.sg](http://www.nuovocorso.sg)

---

**NUOVOCORSO  
SINTERED STONE**

---

**AZUL BAHIA**

---

Suitable for Kitchen Countertops,  
Backsplashes, Dining Tables,  
Vanities, Feature Walls,  
Bathrooms, Floors and the  
Ventilated Facades.

  
**BIGSLABS**®  
BY  
nuovocorso  
Made in Italy

PREMIUM SINTERED  
STONE MANUFACTURER



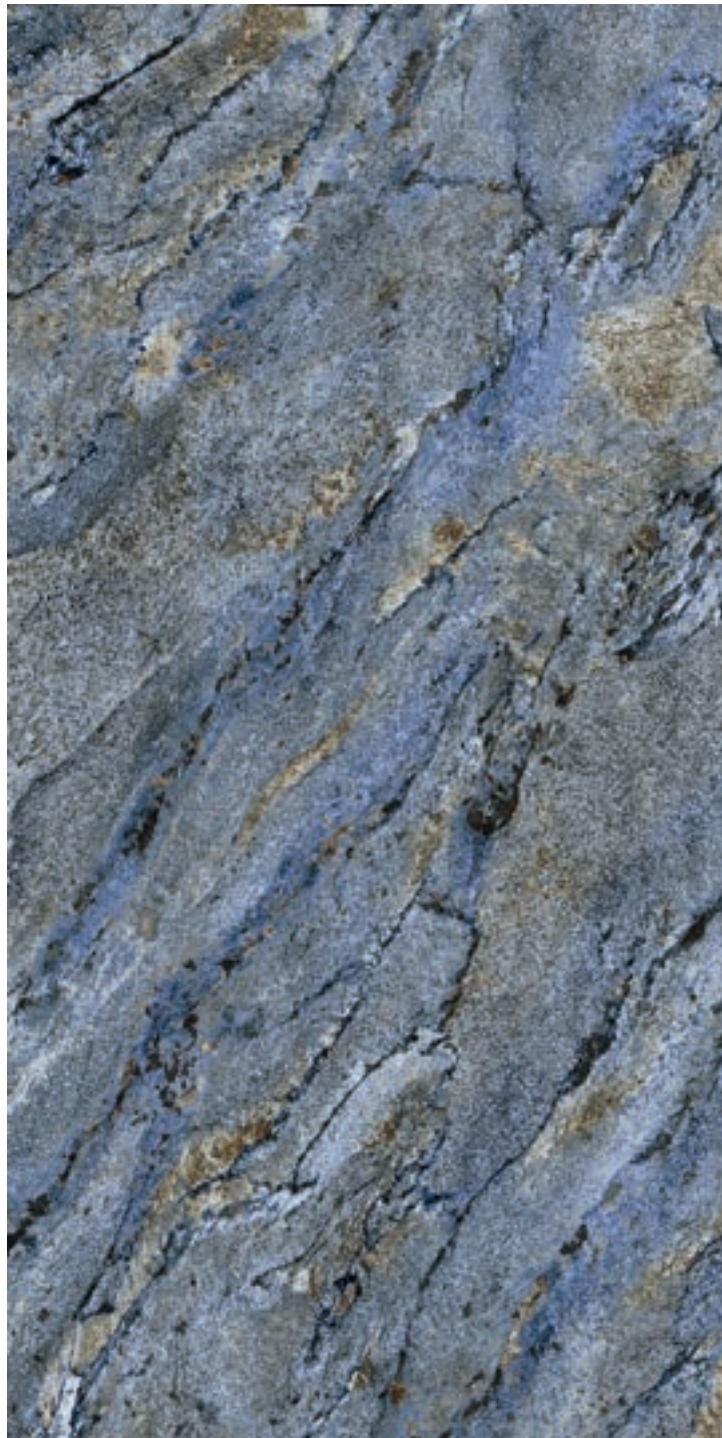

# AZUL BAHIA

## SINTERED STONE

### FORMATO / SIZE



**162x324 cm** 64"x127"  
full size (12 mm)

**160x320 cm** 63"x126"  
Rett. Rect. (6,5 mm)

### SPESSORI / THICKNESSES



**6,5 mm** 0.25"  
**12 mm** 0.47"

### FINITURE / FINISHES



**Naturale Matt**  
**Levigato Polished**

Stuoia disponibile, a pagamento, su richiesta.  
Fiber available upon request, with surcharge.

  
**BIGSLABS**<sup>®</sup>  
BY  
**nuovocorso**  
Made in Italy

PREMIUM SINTERED  
STONE MANUFACTURER

[www.nuovocorso.sg](http://www.nuovocorso.sg)

---

## NUOVOCORSO SINTERED STONE

---

### BALLET

---

Suitable for Kitchen Countertops,  
Backsplashes, Dining Tables,  
Vanities, Feature Walls,  
Bathrooms, Floors and the  
Ventilated Facades.

  
**BIGSLABS**®  
BY  
nuovocorso  
Made in Italy

PREMIUM SINTERED  
STONE MANUFACTURER





# BALLET

---

## SINTERED STONE

### FORMATO / SIZE



**162x324 cm** 64"x127"  
full size (12 mm / 2 cm)

**160x320 cm** 63"x126"  
Rett. Rect. (6,5 mm)

### SPESSORI / THICKNESSES



**6,5 mm** 0.25"  
**12 mm** 0.47"  
**2 cm** 0.78"

### FINITURE / FINISHES



**Naturale Matt**  
**Levigato Polished**

Stuoia disponibile, a pagamento, su richiesta.  
Fiber available upon request, with surcharge.

  
**BIGSLABS**<sup>®</sup>  
BY  
**.nuovocorso**  
Made in Italy

PREMIUM SINTERED  
STONE MANUFACTURER

[www.nuovocorso.sg](http://www.nuovocorso.sg)

---

**NUOVOCORSO  
SINTERED STONE**

---

**BASALTINA  
GRIGIA**

---

Suitable for Kitchen Countertops,  
Backsplashes, Dining Tables,  
Vanities, Feature Walls,  
Bathrooms, Floors and the  
Ventilated Facades.

  
**BIGSLABS**®  
BY  
nuovocorso  
Made in Italy

PREMIUM SINTERED  
STONE MANUFACTURER



# BASALTINA GRIGIA

---

## SINTERED STONE

### FORMATO / SIZE



**162x324 cm** 64"x127"  
full size

### SPESSORI / THICKNESSES



**12 mm** 0.47"

### FINITURE / FINISHES



**Soft Structured**

Stuoia disponibile, a pagamento, su richiesta.  
Fiber available upon request, with surcharge.

  
**BIGSLABS**<sup>®</sup>  
BY  
**.nuovocorso**  
Made in Italy

PREMIUM SINTERED  
STONE MANUFACTURER

[www.nuovocorso.sg](http://www.nuovocorso.sg)

**NUOVOCORSO  
SINTERED STONE**

## **BASALTINA NERA**

Suitable for Kitchen Countertops,  
Backsplashes, Dining Tables,  
Vanities, Feature Walls,  
Bathrooms, Floors and the  
Ventilated Facades.



  
**BIGSLABS**®  
BY  
nuovocorso  
Made in Italy

PREMIUM SINTERED  
STONE MANUFACTURER



# BASALTINA NERA

SINTERED STONE

## FORMATO / SIZE



**162x324 cm** 64"x127"  
full size (12 mm)

**160x320 cm** 63"x126"  
**Rett. Rect.** (6,5 mm)

## SPESSORI / THICKNESSES



**6,5 mm** 0.25"  
**12 mm** 0.47"

## FINITURE / FINISHES



**Soft Structured**

Stuoia disponibile, a pagamento, su richiesta.  
Fiber available upon request, with surcharge.

  
**BIGSLABS**®  
BY  
**nuovocorso**  
Made in Italy

PREMIUM SINTERED  
STONE MANUFACTURER



[www.nuovocorso.sg](http://www.nuovocorso.sg)

---

**NUOVOCORSO  
SINTERED STONE**

---

**BIANCO  
NAMIBIA**

---

Suitable for Kitchen Countertops,  
Backsplashes, Dining Tables,  
Vanities, Feature Walls,  
Bathrooms, Floors and the  
Ventilated Facades.

  
**BIGSLABS**®  
BY  
nuovocorso  
Made in Italy

PREMIUM SINTERED  
STONE MANUFACTURER



# BIANCO NAMIBIA

SINTERED STONE

## FORMATO / SIZE



**162x324 cm** 64"x127"  
full size (12 mm / 2 cm)

**160x320 cm** 63"x126"  
**Rett. Rect.** (6,5 mm)

## SPESSORI / THICKNESSES



**6,5 mm** 0.25"  
**12 mm** 0.47"  
**2 cm** 0.78"

## FINITURE / FINISHES



**Naturale** Matt  
**Levigato** Polished  
**Honed** Honed

Stuoia disponibile, a pagamento, su richiesta.  
Fiber available upon request, with surcharge.

  
**BIGSLABS**<sup>®</sup>  
BY  
**.nuovocorso**  
Made in Italy

PREMIUM SINTERED  
STONE MANUFACTURER

[www.nuovocorso.sg](http://www.nuovocorso.sg)

**NUOVOCORSO  
SINTERED STONE**

## **BLACK DIAMOND**

Suitable for Kitchen Countertops,  
Backsplashes, Dining Tables,  
Vanities, Feature Walls,  
Bathrooms, Floors and the  
Ventilated Facades.

  
**BIGSLABS**®  
BY  
nuovocorso  
Made in Italy

PREMIUM SINTERED  
STONE MANUFACTURER





# BLACK DIAMOND

SINTERED STONE

## FORMATO / SIZE



**162x324 cm** 64"x127"  
full size (12 mm)

**160x320 cm** 63"x126"  
Rett. Rect. (6,5 mm)

## SPESSORI / THICKNESSES



**6,5 mm** 0.25"  
**12 mm** 0.47"

## FINITURE / FINISHES



**Naturale Matt**  
**Levigato Polished**

Stuoia disponibile, a pagamento, su richiesta.  
Fiber available upon request, with surcharge.

  
**BIGSLABS**<sup>®</sup>  
BY  
**.nuovocorso**  
Made in Italy

PREMIUM SINTERED  
STONE MANUFACTURER

[www.nuovocorso.sg](http://www.nuovocorso.sg)

## NUOVOCORSO SINTERED STONE

# BLACK GOLD

Suitable for Kitchen Countertops,  
Backsplashes, Dining Tables,  
Vanities, Feature Walls,  
Bathrooms, Floors and the  
Ventilated Facades.

  
**BIGSLABS**®  
BY  
nuovocorso  
Made in Italy

PREMIUM SINTERED  
STONE MANUFACTURER





# BLACK GOLD

## SINTERED STONE

### FORMATO / SIZE



**162x324 cm** 64"x127"  
full size (12 mm)

**160x320 cm** 63"x126"  
Rett. Rect. (6,5 mm)

### SPESSORI / THICKNESSES



**6,5 mm** 0.25"  
**12 mm** 0.47"

### FINITURE / FINISHES



**Naturale Matt**  
**Levigato Polished**

Stuoia disponibile, a pagamento, su richiesta.  
Fiber available upon request, with surcharge.

  
**BIGSLABS**<sup>®</sup>  
BY  
**.nuovocorso**  
Made in Italy

PREMIUM SINTERED  
STONE MANUFACTURER

[www.nuovocorso.sg](http://www.nuovocorso.sg)

## **NUOVOCORSO SINTERED STONE**

# **BORGHETTO**

Suitable for Kitchen Countertops,  
Backsplashes, Dining Tables,  
Vanities, Feature Walls,  
Bathrooms, Floors and the  
Ventilated Facades.

  
**BIGSLABS**®  
BY  
nuovocorso  
Made in Italy

PREMIUM SINTERED  
STONE MANUFACTURER





# BORGHETTO

## SINTERED STONE

### FORMATO / SIZE



**162x324 cm** 64"x127"  
full size (12 mm / 2 cm)

**160x320 cm** 63"x126"  
Rett. Rect. (6,5 mm)

### SPESSORI / THICKNESSES



**6,5 mm** 0.25"  
**12 mm** 0.47"  
**2 cm** 0.78"

### FINITURE / FINISHES



**Naturale** Matt  
**Levigato** Polished  
**Honed** Honed

Stuoia disponibile, a pagamento, su richiesta.  
Fiber available upon request, with surcharge.

  
**BIGSLABS**®  
BY  
**.nuovocorso**  
Made in Italy

PREMIUM SINTERED  
STONE MANUFACTURER

[www.nuovocorso.sg](http://www.nuovocorso.sg)

---

**NUOVOCORSO  
SINTERED STONE**

---

**BOULEVARD  
BLACK**

---

Suitable for Kitchen Countertops,  
Backsplashes, Dining Tables,  
Vanities, Feature Walls,  
Bathrooms, Floors and the  
Ventilated Facades.

  
**BIGSLABS**®  
BY  
nuovocorso  
Made in Italy

PREMIUM SINTERED  
STONE MANUFACTURER



# BOULEVARD BLACK

---

## SINTERED STONE

### FORMATO / SIZE



**162x324 cm** 64"x127"  
full size

### SPESSORI / THICKNESSES



**12 mm** 0.47"

### FINITURE / FINISHES



**Soft Structured**

Stuoia disponibile, a pagamento, su richiesta.  
Fiber available upon request, with surcharge.

  
BY  
**.nuovocorso**  
Made in Italy

PREMIUM SINTERED  
STONE MANUFACTURER

[www.nuovocorso.sg](http://www.nuovocorso.sg)

**NUOVOCORSO  
SINTERED STONE**

## **BOULEVARD GREY**

Suitable for Kitchen Countertops,  
Backsplashes, Dining Tables,  
Vanities, Feature Walls,  
Bathrooms, Floors and the  
Ventilated Facades.

  
**BIGSLABS**®  
BY  
nuovocorso  
Made in Italy

PREMIUM SINTERED  
STONE MANUFACTURER





# BOULEVARD GREY

SINTERED STONE

## FORMATO / SIZE



**162x324 cm** 64"x127"  
full size (12 mm)

**160x320 cm** 63"x126"  
**Rett. Rect.** (6,5 mm)

## SPESSORI / THICKNESSES



**6,5 mm** 0.25"  
**12 mm** 0.47"

## FINITURE / FINISHES



**Soft Structured**

Stuoia disponibile, a pagamento, su richiesta.  
Fiber available upon request, with surcharge.

  
**BIGSLABS**<sup>®</sup>  
BY  
**nuovocorso**  
Made in Italy

PREMIUM SINTERED  
STONE MANUFACTURER

[www.nuovocorso.sg](http://www.nuovocorso.sg)

**NUOVOCORSO  
SINTERED STONE**

## **BOULEVARD WHITE**

Suitable for Kitchen Countertops,  
Backsplashes, Dining Tables,  
Vanities, Feature Walls,  
Bathrooms, Floors and the  
Ventilated Facades.

  
**BIGSLABS**®  
BY  
nuovocorso  
Made in Italy

PREMIUM SINTERED  
STONE MANUFACTURER



# BOULEVARD WHITE

---

## SINTERED STONE

### FORMATO / SIZE



**162x324 cm** 64"x127"  
full size (12 mm)

**160x320 cm** 63"x126"  
**Rett. Rect.** (6,5 mm)

### SPESSORI / THICKNESSES



**6,5 mm** 0.25"  
**12 mm** 0.47"

### FINITURE / FINISHES



**Soft Structured**

Stuoia disponibile, a pagamento, su richiesta.  
Fiber available upon request, with surcharge.

  
**BIGSLABS**®  
BY  
**.nuovocorso**  
Made in Italy

PREMIUM SINTERED  
STONE MANUFACTURER

[www.nuovocorso.sg](http://www.nuovocorso.sg)

---

**NUOVOCORSO  
SINTERED STONE**

---

**BRECCIA  
REALE**

---

Suitable for Kitchen Countertops,  
Backsplashes, Dining Tables,  
Vanities, Feature Walls,  
Bathrooms, Floors and the  
Ventilated Facades.

  
**BIGSLABS**®  
BY  
nuovocorso  
Made in Italy

PREMIUM SINTERED  
STONE MANUFACTURER





# BRECCIA REALE

SINTERED STONE

## FORMATO / SIZE



**162x324 cm** 64"x127"  
full size (12 mm)

**160x320 cm** 63"x126"  
Rett. Rect. (6,5 mm)

## SPESSORI / THICKNESSES



**6,5 mm** 0.25"  
**12 mm** 0.47"

## FINITURE / FINISHES



**Naturale** Matt  
**Levigato** Polished  
**Honed** Honed

Stuoia disponibile, a pagamento, su richiesta.  
Fiber available upon request, with surcharge.

  
**BIGSLABS**<sup>®</sup>  
BY  
**.nuovocorso**  
Made in Italy

PREMIUM SINTERED  
STONE MANUFACTURER

[www.nuovocorso.sg](http://www.nuovocorso.sg)

**NUOVOCORSO  
SINTERED STONE**

## **BRECCIA SICILIANA**

Suitable for Kitchen Countertops,  
Backsplashes, Dining Tables,  
Vanities, Feature Walls,  
Bathrooms, Floors and the  
Ventilated Facades.

  
**BIGSLABS**®  
BY  
**nuovocorso**  
Made in Italy

PREMIUM SINTERED  
STONE MANUFACTURER





# BRECCIA SICILIANA

SINTERED STONE

## FORMATO / SIZE



**162x324 cm** 64"x127"  
full size (12 mm)

**160x320 cm** 63"x126"  
Rett. Rect. (6,5 mm)

## SPESSORI / THICKNESSES



**6,5 mm** 0.25"  
**12 mm** 0.47"

## FINITURE / FINISHES



### ART 5D TECHNOLOGY SURFACE

Finishing, which combines on the same slab glossy and matt areas. The matt areas can have a satin or structured finish, for a pleasant and unusual tactile sensation.

  
**BIGSLABS**®  
BY  
nuovocorso  
Made in Italy

PREMIUM SINTERED  
STONE MANUFACTURER

[www.nuovocorso.sg](http://www.nuovocorso.sg)

**NUOVOCORSO  
SINTERED STONE**

## **BRECCIA STONE BEIGE**

Suitable for Kitchen Countertops,  
Backsplashes, Dining Tables,  
Vanities, Feature Walls,  
Bathrooms, Floors and the  
Ventilated Facades.

  
**BIGSLABS**®  
BY  
nuovocorso  
Made in Italy

PREMIUM SINTERED  
STONE MANUFACTURER



# BRECCIA STONE BEIGE

SINTERED STONE

## FORMATO / SIZE



**162x324 cm** 64"x127"  
full size (12 mm)

**160x320 cm** 63"x126"  
Rett. Rect. (6,5 mm)

## SPESSORI / THICKNESSES



**6,5 mm** 0.25"  
**12 mm** 0.47"

## FINITURE / FINISHES



**Naturale** Matt  
**Honed** Honed

Stuoia disponibile, a pagamento, su richiesta.  
Fiber available upon request, with surcharge.

  
**BIGSLABS**®  
BY  
**.nuovocorso**  
Made in Italy

PREMIUM SINTERED  
STONE MANUFACTURER

[www.nuovocorso.sg](http://www.nuovocorso.sg)

**NUOVOCORSO  
SINTERED STONE**

## **BRECCIA STONE WHITE**

Suitable for Kitchen Countertops,  
Backsplashes, Dining Tables,  
Vanities, Feature Walls,  
Bathrooms, Floors and the  
Ventilated Facades.

  
**BIGSLABS**®  
BY  
nuovocorso  
Made in Italy

PREMIUM SINTERED  
STONE MANUFACTURER





# BRECCIA STONE WHITE

SINTERED STONE

## FORMATO / SIZE



**162x324 cm** 64"x127"  
full size (12 mm)

**160x320 cm** 63"x126"  
Rett. Rect. (6,5 mm)

## SPESSORI / THICKNESSES



**6,5 mm** 0.25"  
**12 mm** 0.47"

## FINITURE / FINISHES



**Naturale** Matt  
**Honed** Honed

Stuoia disponibile, a pagamento, su richiesta.  
Fiber available upon request, with surcharge.

  
**BIGSLABS**®  
BY  
**.nuovocorso**  
Made in Italy

PREMIUM SINTERED  
STONE MANUFACTURER

[www.nuovocorso.sg](http://www.nuovocorso.sg)

**NUOVOCORSO  
SINTERED STONE**

## **CALACATTA DORATO**

Suitable for Kitchen Countertops,  
Backsplashes, Dining Tables,  
Vanities, Feature Walls,  
Bathrooms, Floors and the  
Ventilated Facades.

  
**BIGSLABS**®  
BY  
nuovocorso  
Made in Italy

PREMIUM SINTERED  
STONE MANUFACTURER



# CALACATTA DORATO

SINTERED STONE

## FORMATO / SIZE



**162x324 cm** 64"x127"  
full size (12 mm / 2 cm)

**160x320 cm** 63"x126"  
Rett. Rect. (6,5 mm)

## SPESSORI / THICKNESSES



**6,5 mm** 0.25"  
**12 mm** 0.47"  
**2 cm** 0.78"

## FINITURE / FINISHES



**Naturale** Matt  
**Levigato** Polished  
**Honed** Honed

Stuoia disponibile, a pagamento, su richiesta.  
Fiber available upon request, with surcharge.

  
**BIGSLABS**<sup>®</sup>  
BY  
**.nuovocorso**  
Made in Italy

PREMIUM SINTERED  
STONE MANUFACTURER

[www.nuovocorso.sg](http://www.nuovocorso.sg)

**NUOVOCORSO  
SINTERED STONE**

**CALACATTA  
ORO**

**12mm / 2cm**

Suitable for Kitchen Countertops,  
Backsplashes, Dining Tables,  
Vanities, Feature Walls,  
Bathrooms, Floors and the  
Ventilated Facades.

  
**BIGSLABS**®  
BY  
nuovocorso  
Made in Italy

PREMIUM SINTERED  
STONE MANUFACTURER





# CALACATTA ORO

SINTERED STONE

## FORMATO / SIZE



**162x324 cm** 64"x127"  
full size

## SPESSORI / THICKNESSES



**12 mm** 0.47"  
**2 cm** 0.78"

## FINITURE / FINISHES



**Naturale** Matt  
**Levigato** Polished  
**Honed** Honed

Stuoia disponibile, a pagamento, su richiesta.  
Fiber available upon request, with surcharge.

  
**BIGSLABS**®  
BY  
**.nuovocorso**  
Made in Italy

PREMIUM SINTERED  
STONE MANUFACTURER

[www.nuovocorso.sg](http://www.nuovocorso.sg)

**NUOVOCORSO  
SINTERED STONE**

**CALACATTA  
ORO**

**6,5mm**

Suitable for Kitchen Countertops,  
Backsplashes, Dining Tables,  
Vanities, Feature Walls,  
Bathrooms, Floors and the  
Ventilated Facades.

  
**BIGSLABS**®  
BY  
**nuovocorso**  
Made in Italy

PREMIUM SINTERED  
STONE MANUFACTURER



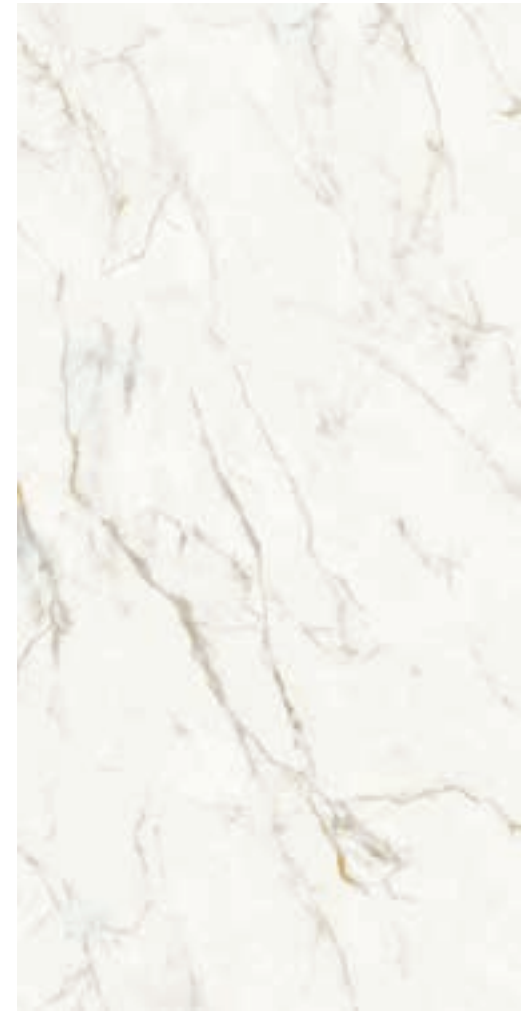
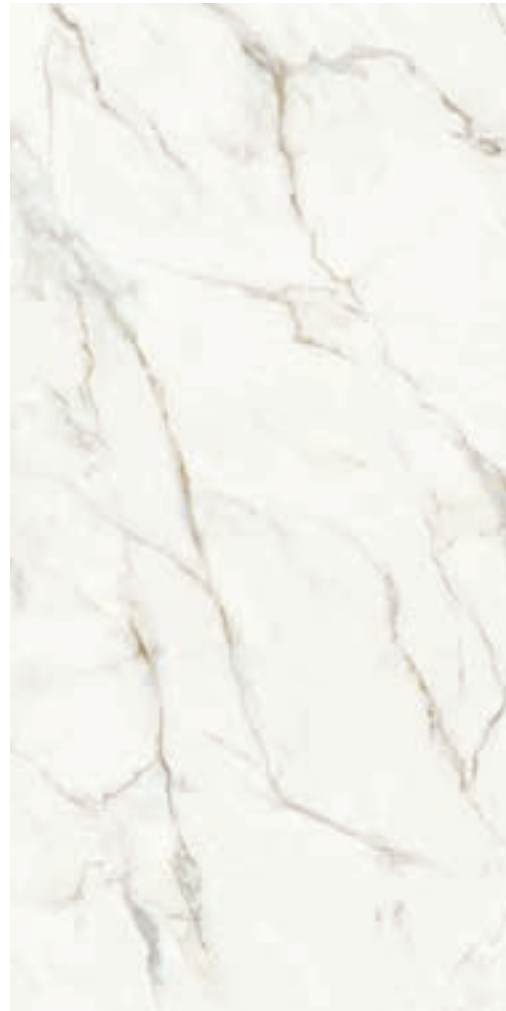

# CALACATTA ORO

SINTERED STONE

FINITURE / FINISHES

SPESSORI / THICKNESSES

FORMATO / SIZE



**Naturale** Matt  
**Levigato** Polished  
**Honed** Honed



**6,5 mm** 0.25"



**160x320 cm** 63"x126"  
**Rett. Rect.**

Stuoia disponibile, a pagamento, su richiesta.  
Fiber available upon request, with surcharge.

**BIGSLABS®**  
BY  
**nuovocorso**  
Made in Italy

PREMIUM SINTERED  
STONE MANUFACTURER

[www.nuovocorso.sg](http://www.nuovocorso.sg)

**NUOVOCORSO  
SINTERED STONE**

## **CALACATTA VIOLA**

Suitable for Kitchen Countertops,  
Backsplashes, Dining Tables,  
Vanities, Feature Walls,  
Bathrooms, Floors and the  
Ventilated Facades.



  
**BIGSLABS**®  
BY  
**nuovocorso**  
Made in Italy

PREMIUM SINTERED  
STONE MANUFACTURER



# CALACATTA VIOLA

SINTERED STONE

## FORMATO / SIZE



**162x324 cm** 64"x127"  
full size (12 mm/2cm)

**160x320 cm** 63"x126"  
Rett. Rect. (6,5 mm)

## SPESSORI / THICKNESSES



**6,5 mm** 0.25"  
**12 mm** 0.47"  
**2cm** 0.78"

## FINITURE / FINISHES



**Levigato** Polished  
**Honed** Honed

Stuoia disponibile, a pagamento, su richiesta.  
Fiber available upon request, with surcharge.

  
**BIGSLABS**®  
BY  
**nuovocorso**  
Made in Italy

PREMIUM SINTERED  
STONE MANUFACTURER

[www.nuovocorso.sg](http://www.nuovocorso.sg)

**NUOVOCORSO  
SINTERED STONE**

## **CALACATTA WHITE**

Suitable for Kitchen Countertops,  
Backsplashes, Dining Tables,  
Vanities, Feature Walls,  
Bathrooms, Floors and the  
Ventilated Facades.

  
**BIGSLABS**®  
BY  
**nuovocorso**  
Made in Italy

PREMIUM SINTERED  
STONE MANUFACTURER





# CALACATTA WHITE

SINTERED STONE

## FORMATO / SIZE



**162x324 cm** 64"x127"  
full size (12 mm)

**160x320 cm** 63"x126"  
Rett. Rect. (6,5 mm)

## SPESSORI / THICKNESSES



**6,5 mm** 0.25"  
**12 mm** 0.47"

## FINITURE / FINISHES



**Naturale Matt**  
**Levigato Polished**

Stuoia disponibile, a pagamento, su richiesta.  
Fiber available upon request, with surcharge.

  
**BIGSLABS**®  
BY  
**.nuovocorso**  
Made in Italy

PREMIUM SINTERED  
STONE MANUFACTURER

---

**NUOVOCORSO  
SINTERED STONE**

---

**CEMENT  
ANTHRACITE**

---

Suitable for Kitchen Countertops,  
Backsplashes, Dining Tables,  
Vanities, Feature Walls,  
Bathrooms, Floors and the  
Ventilated Facades.

  
**BIGSLABS**®  
BY  
nuovocorso  
Made in Italy

PREMIUM SINTERED  
STONE MANUFACTURER





# CEMENT ANTHRACITE

---

## SINTERED STONE

### FORMATO / SIZE



**162x324 cm** 64"x127"  
full size

### SPESSORI / THICKNESSES



**12 mm** 0.47"

### FINITURE / FINISHES



**Soft Structured**

Stuoia disponibile, a pagamento, su richiesta.  
Fiber available upon request, with surcharge.

  
**BIGSLABS**®  
BY  
**nuovocorso**  
Made in Italy

PREMIUM SINTERED  
STONE MANUFACTURER

[www.nuovocorso.sg](http://www.nuovocorso.sg)

---

**NUOVOCORSO  
SINTERED STONE**

---

**CEMENT  
ASH**

---

Suitable for Kitchen Countertops,  
Backsplashes, Dining Tables,  
Vanities, Feature Walls,  
Bathrooms, Floors and the  
Ventilated Facades.



  
**BIGSLABS**®  
BY  
**nuovocorso**  
Made in Italy

PREMIUM SINTERED  
STONE MANUFACTURER



# CEMENT ASH

---

## SINTERED STONE

### FORMATO / SIZE



**162x324 cm** 64"x127"  
full size

### SPESSORI / THICKNESSES



**12 mm** 0.47"

### FINITURE / FINISHES



**Soft Structured**

Stuoia disponibile, a pagamento, su richiesta.  
Fiber available upon request, with surcharge.

  
**BIGSLABS**<sup>®</sup>  
BY  
**.nuovocorso**  
Made in Italy

PREMIUM SINTERED  
STONE MANUFACTURER

[www.nuovocorso.sg](http://www.nuovocorso.sg)

**NUOVOCORSO  
SINTERED STONE**

**CEMENT  
WHITE**

Suitable for Kitchen Countertops,  
Backsplashes, Dining Tables,  
Vanities, Feature Walls,  
Bathrooms, Floors and the  
Ventilated Facades.

  
**BIGSLABS**®  
BY  
nuovocorso  
Made in Italy

PREMIUM SINTERED  
STONE MANUFACTURER





# CEMENT WHITE

---

## SINTERED STONE

### FORMATO / SIZE



**162x324 cm** 64"x127"  
full size (12 mm)

**160x320 cm** 63"x126"  
**Rett. Rect.** (6,5 mm)

### SPESSORI / THICKNESSES



**6,5 mm** 0.25"  
**12 mm** 0.47"

### FINITURE / FINISHES



**Soft Structured**

Stuoia disponibile, a pagamento, su richiesta.  
Fiber available upon request, with surcharge.

  
**BIGSLABS**®  
BY  
**nuovocorso**  
Made in Italy

PREMIUM SINTERED  
STONE MANUFACTURER

[www.nuovocorso.sg](http://www.nuovocorso.sg)

---

**NUOVOCORSO  
SINTERED STONE**

---

## **CEPPO DI GRÈ**

---

Suitable for Kitchen Countertops,  
Backsplashes, Dining Tables,  
Vanities, Feature Walls,  
Bathrooms, Floors and the  
Ventilated Facades.

  
**BIGSLABS**®  
BY  
**nuovocorso**  
Made in Italy

PREMIUM SINTERED  
STONE MANUFACTURER





# CEPPO DI GRÈ

---

## SINTERED STONE

### FORMATO / SIZE



**162x324 cm** 64"x127"  
full size

### SPESSORI / THICKNESSES



**12 mm** 0.47"

### FINITURE / FINISHES



**Soft Structured**

Stuoia disponibile, a pagamento, su richiesta.  
Fiber available upon request, with surcharge.

  
**BIGSLABS**®  
BY  
**nuovocorso**  
Made in Italy

PREMIUM SINTERED  
STONE MANUFACTURER

[www.nuovocorso.sg](http://www.nuovocorso.sg)

---

**NUOVOCORSO  
SINTERED STONE**

---

**COLORADO**

---

Suitable for Kitchen Countertops,  
Backsplashes, Dining Tables,  
Vanities, Feature Walls,  
Bathrooms, Floors and the  
Ventilated Facades.

  
**BIGSLABS**®  
BY  
  
Made in Italy

PREMIUM SINTERED  
STONE MANUFACTURER



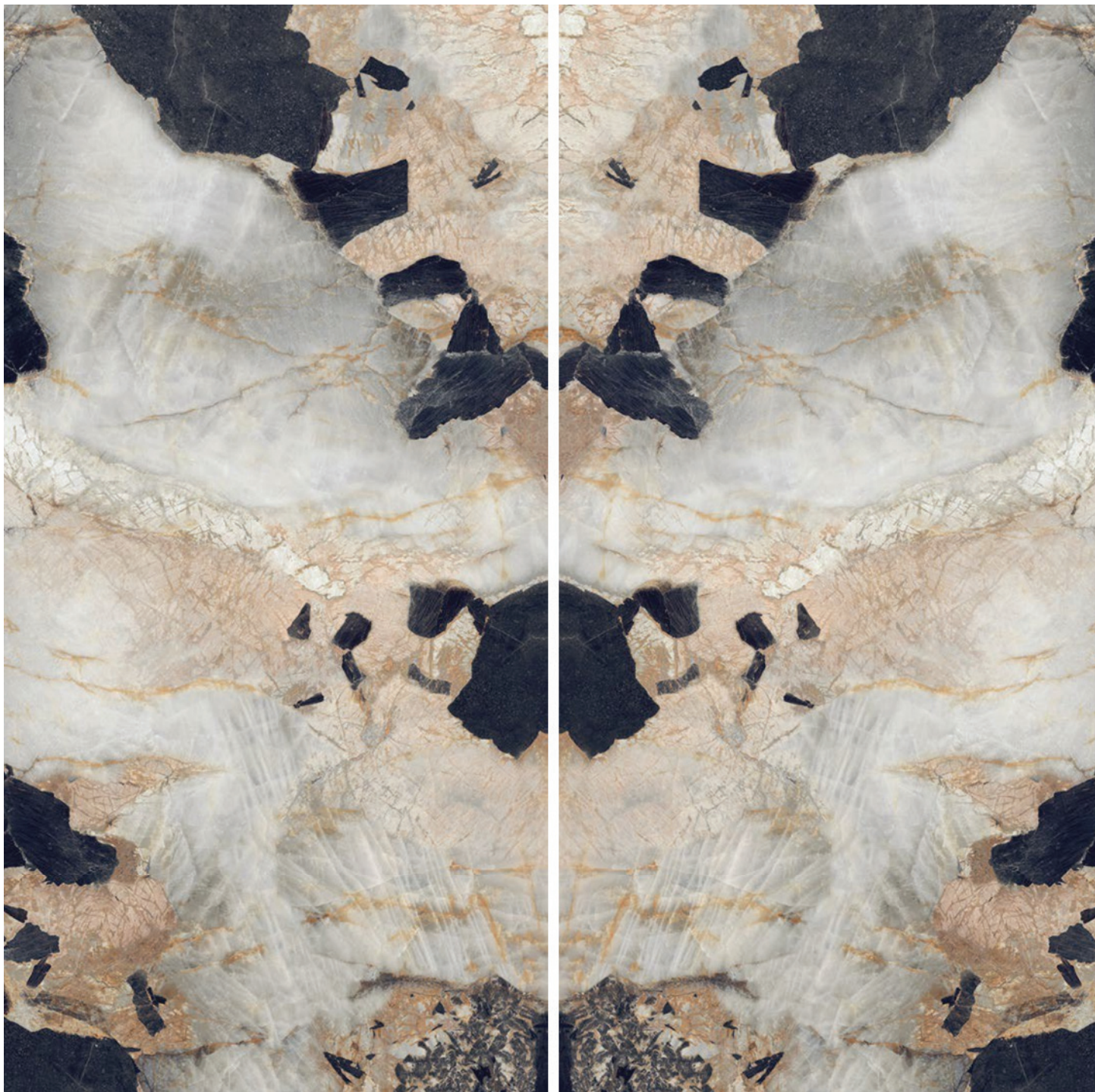

# COLORADO

## SINTERED STONE

### FORMATO / SIZE



**162x324 cm** 64"x127"  
full size (12 mm)

**160x320 cm** 63"x126"  
Rett. Rect. (6,5 mm)

### SPESSORI / THICKNESSES



**6,5 mm** 0.25"  
**12 mm** 0.47"

### FINITURE / FINISHES



**Levigato** Polished  
**Honed** Honed

Stuoia disponibile, a pagamento, su richiesta.  
Fiber available upon request, with surcharge.

  
**BIGSLABS**®  
BY  
**nuovocorso**  
Made in Italy

PREMIUM SINTERED  
STONE MANUFACTURER

[www.nuovocorso.sg](http://www.nuovocorso.sg)

**NUOVOCORSO  
SINTERED STONE**

## **CONCRETE ASH**

Suitable for Kitchen Countertops,  
Backsplashes, Dining Tables,  
Vanities, Feature Walls,  
Bathrooms, Floors and the  
Ventilated Facades.

  
**BIGSLABS**®  
BY  
nuovocorso  
Made in Italy

PREMIUM SINTERED  
STONE MANUFACTURER





# CONCRETE ASH

## SINTERED STONE

### FORMATO / SIZE



**162x324 cm** 64"x127"  
full size (12 mm)

**160x320 cm** 63"x126"  
**Rett. Rect.** (6,5 mm)

### SPESSORI / THICKNESSES



**6,5 mm** 0.25"  
**12 mm** 0.47"

### FINITURE / FINISHES



**Soft Structured**

Stuoia disponibile, a pagamento, su richiesta.  
Fiber available upon request, with surcharge.

  
**BIGSLABS**®  
BY  
**.nuovocorso**  
Made in Italy

PREMIUM SINTERED  
STONE MANUFACTURER

[www.nuovocorso.sg](http://www.nuovocorso.sg)

**NUOVOCORSO  
SINTERED STONE**

## **CREMO DELICATO**

Suitable for Kitchen Countertops,  
Backsplashes, Dining Tables,  
Vanities, Feature Walls,  
Bathrooms, Floors and the  
Ventilated Facades.

  
**BIGSLABS**®  
BY  
nuovocorso  
Made in Italy

PREMIUM SINTERED  
STONE MANUFACTURER





# CREMO DELICATO

SINTERED STONE

## FORMATO / SIZE



**162x324 cm** 64"x127"  
full size (12 mm/2cm)

**160x320 cm** 63"x126"  
Rett. Rect. (6,5 mm)

## SPESSORI / THICKNESSES



**6,5 mm** 0.25"  
**12 mm** 0.47"  
**2cm** 0.78"

## FINITURE / FINISHES



**Naturale** Matt  
**Levigato** Polished  
**Honed** Honed

Stuoia disponibile, a pagamento, su richiesta.  
Fiber available upon request, with surcharge.

  
**BIGSLABS**<sup>®</sup>  
BY  
**.nuovocorso**  
Made in Italy

PREMIUM SINTERED  
STONE MANUFACTURER

[www.nuovocorso.sg](http://www.nuovocorso.sg)

**NUOVOCORSO  
SINTERED STONE**

## **EMOTION EUPHORIA**

Suitable for Kitchen Countertops,  
Backsplashes, Dining Tables,  
Vanities, Feature Walls,  
Bathrooms, Floors and the  
Ventilated Facades.

  
**BIGSLABS**®  
BY  
nuovocorso  
Made in Italy

PREMIUM SINTERED  
STONE MANUFACTURER





# EMOTION EUPHORIA

## SINTERED STONE

### FORMATO / SIZE



**162x324 cm** 64"x127"  
full size (12 mm)

**160x320 cm** 63"x126"  
Rett. Rect. (6,5 mm)

### SPESSORI / THICKNESSES



**6,5 mm** 0.25"  
**12 mm** 0.47"

### FINITURE / FINISHES



**Levigato** Polished

Stuoia disponibile, a pagamento, su richiesta.  
Fiber available upon request, with surcharge.

  
**BIGSLABS**<sup>®</sup>  
BY  
**.nuovocorso**  
Made in Italy

PREMIUM SINTERED  
STONE MANUFACTURER

[www.nuovocorso.sg](http://www.nuovocorso.sg)

---

**NUOVOCORSO  
SINTERED STONE**

---

**EMOTION  
HOPE**

---

Suitable for Kitchen Countertops,  
Backsplashes, Dining Tables,  
Vanities, Feature Walls,  
Bathrooms, Floors and the  
Ventilated Facades.

  
**BIGSLABS®**  
BY  
**nuovocorso**  
Made in Italy

PREMIUM SINTERED  
STONE MANUFACTURER



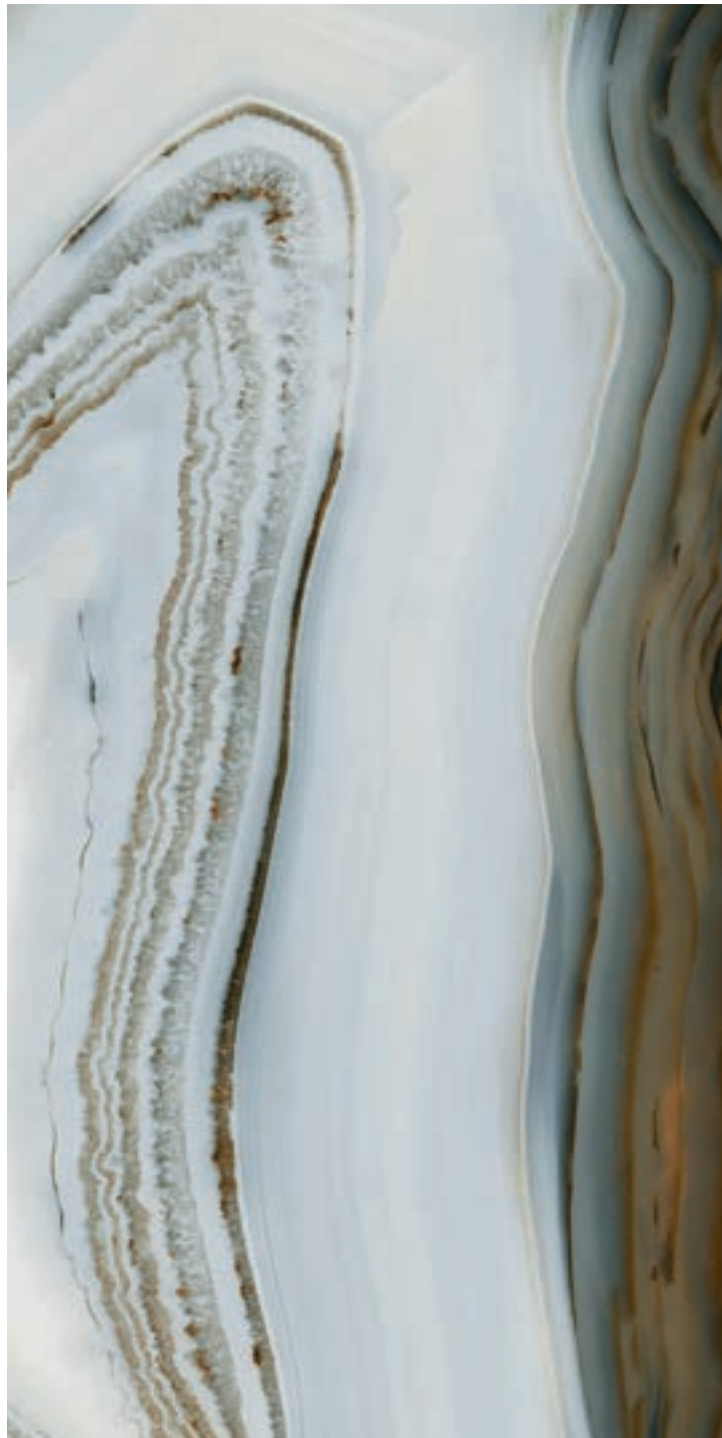

# EMOTION HOPE

SINTERED STONE

## FORMATO / SIZE



**162x324 cm** 64"x127"  
full size (12 mm)

**160x320 cm** 63"x126"  
Rett. Rect. (6,5 mm)

## SPESSORI / THICKNESSES



**6,5 mm** 0.25"  
**12 mm** 0.47"

## FINITURE / FINISHES



**Levigato** Polished

Stuoia disponibile, a pagamento, su richiesta.  
Fiber available upon request, with surcharge.

  
**BIGSLABS**<sup>®</sup>  
BY  
**.nuovocorso**  
Made in Italy

PREMIUM SINTERED  
STONE MANUFACTURER

[www.nuovocorso.sg](http://www.nuovocorso.sg)

**NUOVOCORSO  
SINTERED STONE**

## **EMOTION WONDER**

Suitable for Kitchen Countertops,  
Backsplashes, Dining Tables,  
Vanities, Feature Walls,  
Bathrooms, Floors and the  
Ventilated Facades.

  
**BIGSLABS**®  
BY  
nuovocorso  
Made in Italy

PREMIUM SINTERED  
STONE MANUFACTURER





# EMOTION WONDER

---

## SINTERED STONE

### FORMATO / SIZE



**162x324 cm** 64"x127"  
full size (12 mm)

**160x320 cm** 63"x126"  
Rett. Rect. (6,5 mm)

### SPESSORI / THICKNESSES



**6,5 mm** 0.25"  
**12 mm** 0.47"

### FINITURE / FINISHES



**Levigato** Polished

Stuoia disponibile, a pagamento, su richiesta.  
Fiber available upon request, with surcharge.

  
**BIGSLABS**®  
BY  
**.nuovocorso**  
Made in Italy

PREMIUM SINTERED  
STONE MANUFACTURER

[www.nuovocorso.sg](http://www.nuovocorso.sg)

---

**NUOVOCORSO  
SINTERED STONE**

---

**FIOR  
DI BOSCO**

---

Suitable for Kitchen Countertops,  
Backsplashes, Dining Tables,  
Vanities, Feature Walls,  
Bathrooms, Floors and the  
Ventilated Facades.

  
**BIGSLABS**®  
BY  
nuovocorso  
Made in Italy

PREMIUM SINTERED  
STONE MANUFACTURER





# FIOR DI BOSCO

SINTERED STONE

## FORMATO / SIZE



**162x324 cm** 64"x127"  
full size (12 mm)

**160x320 cm** 63"x126"  
Rett. Rect. (6,5 mm)

## SPESSORI / THICKNESSES



**6,5 mm** 0.25"  
**12 mm** 0.47"

## FINITURE / FINISHES



**Naturale Matt**  
**Levigato Polished**

Stuoia disponibile, a pagamento, su richiesta.  
Fiber available upon request, with surcharge.

  
**BIGSLABS**<sup>®</sup>  
BY  
**.nuovocorso**  
Made in Italy

PREMIUM SINTERED  
STONE MANUFACTURER

[www.nuovocorso.sg](http://www.nuovocorso.sg)

---

**NUOVOCORSO  
SINTERED STONE**

---

**GLAM  
GREEN**

---

Suitable for Kitchen Countertops,  
Backsplashes, Dining Tables,  
Vanities, Feature Walls,  
Bathrooms, Floors and the  
Ventilated Facades.

  
**BIGSLABS**®  
BY  
nuovocorso  
Made in Italy

PREMIUM SINTERED  
STONE MANUFACTURER





# GLAM GREEN

## SINTERED STONE

### FORMATO / SIZE



**162x324 cm** 64"x127"  
full size (12 mm)

**160x320 cm** 63"x126"  
Rett. Rect. (6,5 mm)

### SPESSORI / THICKNESSES



**6,5 mm** 0.25"  
**12 mm** 0.47"

### FINITURE / FINISHES



**Levigato** Polished

Stuoia disponibile, a pagamento, su richiesta.  
Fiber available upon request, with surcharge.

  
**BIGSLABS**®  
BY  
**nuovocorso**  
Made in Italy

PREMIUM SINTERED  
STONE MANUFACTURER

[www.nuovocorso.sg](http://www.nuovocorso.sg)

## **NUOVOCORSO SINTERED STONE**

### **GLAM IVORY**

Suitable for Kitchen Countertops,  
Backsplashes, Dining Tables,  
Vanities, Feature Walls,  
Bathrooms, Floors and the  
Ventilated Facades.

  
**BIGSLABS**®  
BY  
nuovocorso  
Made in Italy

PREMIUM SINTERED  
STONE MANUFACTURER





# GLAM IVORY

## SINTERED STONE

### FORMATO / SIZE



**162x324 cm** 64"x127"  
full size (12 mm)

**160x320 cm** 63"x126"  
Rett. Rect. (6,5 mm)

### SPESSORI / THICKNESSES



**6,5 mm** 0.25"  
**12 mm** 0.47"

### FINITURE / FINISHES



**Levigato** Polished

Stuoia disponibile, a pagamento, su richiesta.  
Fiber available upon request, with surcharge.

  
**BIGSLABS**<sup>®</sup>  
BY  
**nuovocorso**  
Made in Italy

PREMIUM SINTERED  
STONE MANUFACTURER

[www.nuovocorso.sg](http://www.nuovocorso.sg)

**NUOVOCORSO  
SINTERED STONE**

## **GOLD CALACATTA**

Suitable for Kitchen Countertops,  
Backsplashes, Dining Tables,  
Vanities, Feature Walls,  
Bathrooms, Floors and the  
Ventilated Facades.

  
**BIGSLABS**®  
BY  
nuovocorso  
Made in Italy

PREMIUM SINTERED  
STONE MANUFACTURER





# **GOLD CALACATTA**

---

## **SINTERED STONE**

### **FORMATO / SIZE**



**162x324 cm** 64"x127"  
full size (12 mm)

**160x320 cm** 63"x126"  
Rett. Rect. (6,5 mm)

### **SPESSORI / THICKNESSES**



**6,5 mm** 0.25"  
**12 mm** 0.47"

### **FINITURE / FINISHES**



**Naturale Matt**  
**Levigato Polished**

Stuoia disponibile, a pagamento, su richiesta.  
Fiber available upon request, with surcharge.

  
**BIGSLABS**®  
BY  
**.nuovocorso**  
Made in Italy

PREMIUM SINTERED  
STONE MANUFACTURER

[www.nuovocorso.sg](http://www.nuovocorso.sg)

**NUOVOCORSO  
SINTERED STONE**

## **GREAT CALACATTA**

**12mm**

Suitable for Kitchen Countertops,  
Backsplashes, Dining Tables,  
Vanities, Feature Walls,  
Bathrooms, Floors and the  
Ventilated Facades.

  
**BIGSLABS**®  
BY  
**nuovocorso**  
Made in Italy

PREMIUM SINTERED  
STONE MANUFACTURER





# GREAT CALACATTA

SINTERED STONE

## FORMATO / SIZE



**162x324 cm** 64"x127"  
full size

## SPESSORI / THICKNESSES



**12 mm** 0.47"

## FINITURE / FINISHES



**Naturale Matt**  
**Levigato Polished**

Stuoia disponibile, a pagamento, su richiesta.  
Fiber available upon request, with surcharge.

  
**BIGSLABS**®  
BY  
**nuovocorso**  
Made in Italy

PREMIUM SINTERED  
STONE MANUFACTURER

**NUOVOCORSO  
SINTERED STONE**

## **GREAT CALACATTA**

**6,5mm**

Suitable for Kitchen Countertops,  
Backsplashes, Dining Tables,  
Vanities, Feature Walls,  
Bathrooms, Floors and the  
Ventilated Facades.

  
**BIGSLABS**®  
BY  
**nuovocorso**  
Made in Italy

PREMIUM SINTERED  
STONE MANUFACTURER



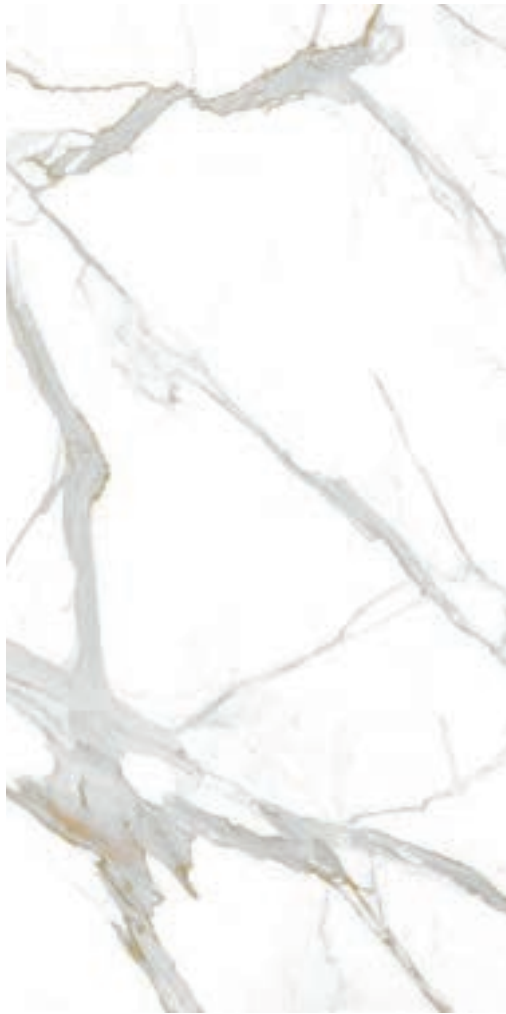

# GREAT CALACATTA

**SINTERED STONE**

**FINITURE / FINISHES**

**SPESSORI / THICKNESSES**

**FORMATO / SIZE**



**Naturale Matt**  
**Levigato Polished**



**6,5 mm 0.25"**



**160x320 cm 63"x126"**  
**Rett. Rect.**

Stuoia disponibile, a pagamento, su richiesta.  
Fiber available upon request, with surcharge.



PREMIUM SINTERED  
STONE MANUFACTURER

[www.nuovocorso.sg](http://www.nuovocorso.sg)

**NUOVOCORSO  
SINTERED STONE**

## **GREEN MAJESTIC**

Suitable for Kitchen Countertops,  
Backsplashes, Dining Tables,  
Vanities, Feature Walls,  
Bathrooms, Floors and the  
Ventilated Facades.

  
**BIGSLABS**®  
BY  
nuovocorso  
Made in Italy

PREMIUM SINTERED  
STONE MANUFACTURER



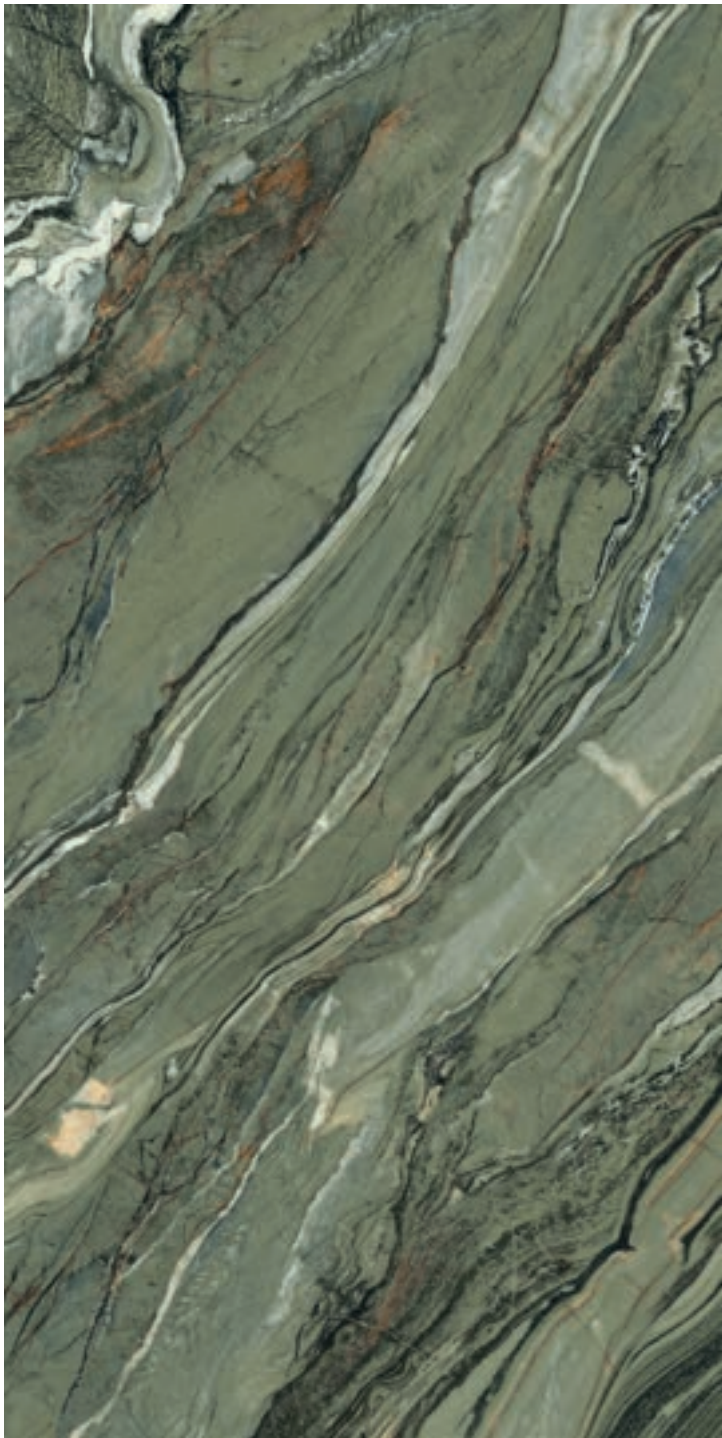

# GREEN MAJESTIC

## SINTERED STONE

### FORMATO / SIZE



**162x324 cm** 64"x127"  
full size (12 mm)

**160x320 cm** 63"x126"  
Rett. Rect. (6,5 mm)

### SPESSORI / THICKNESSES



**6,5 mm** 0.25"  
**12 mm** 0.47"

### FINITURE / FINISHES



**Levigato** Polished  
**Honed** Honed

Stuoia disponibile, a pagamento, su richiesta.  
Fiber available upon request, with surcharge.

  
**BIGSLABS**<sup>®</sup>  
BY  
**.nuovocorso**  
Made in Italy

PREMIUM SINTERED  
STONE MANUFACTURER



[www.nuovocorso.sg](http://www.nuovocorso.sg)

**NUOVOCORSO  
SINTERED STONE**

## **HAMMARVALE**

Suitable for Kitchen Countertops,  
Backsplashes, Dining Tables,  
Vanities, Feature Walls,  
Bathrooms, Floors and the  
Ventilated Facades.

  
**BIGSLABS**®  
BY  
nuovocorso  
Made in Italy

PREMIUM SINTERED  
STONE MANUFACTURER



# HAMMARVALE

## SINTERED STONE

### FORMATO / SIZE



**162x324 cm** 64"x127"  
full size (12 mm)

### SPESSORI / THICKNESSES



**12 mm** 0.47"

### FINITURE / FINISHES



**Naturale Matt**

Stuoia disponibile, a pagamento, su richiesta.  
Fiber available upon request, with surcharge.

  
**BIGSLABS**<sup>®</sup>  
BY  
**nuovocorso**  
Made in Italy

PREMIUM SINTERED  
STONE MANUFACTURER

[www.nuovocorso.sg](http://www.nuovocorso.sg)

---

**NUOVOCORSO  
SINTERED STONE**

---

**HEAVEN  
TRAVERTINO  
BEIGE**

---

Suitable for Kitchen Countertops,  
Backsplashes, Dining Tables,  
Vanities, Feature Walls,  
Bathrooms, Floors and the  
Ventilated Facades.

  
**BIGSLABS**®  
BY  
nuovocorso  
Made in Italy

PREMIUM SINTERED  
STONE MANUFACTURER





# HEAVEN TRAVERTINO BEIGE

---

## SINTERED STONE

### FORMATO / SIZE



**162x324 cm** 64"x127"  
full size (12 mm)

**160x320 cm** 63"x126"  
Rett. Rect. (6,5 mm)

### SPESSORI / THICKNESSES



**6,5 mm** 0.25"  
**12 mm** 0.47"

### FINITURE / FINISHES



**Naturale** Matt  
**Levigato** Polished  
**Honed** Honed

Stuoia disponibile, a pagamento, su richiesta.  
Fiber available upon request, with surcharge.

  
**BIGSLABS**<sup>®</sup>  
BY  
**.nuovocorso**  
Made in Italy

PREMIUM SINTERED  
STONE MANUFACTURER

[www.nuovocorso.sg](http://www.nuovocorso.sg)

**NUOVOCORSO  
SINTERED STONE**

## **HEAVEN TRAVERTINO TAUPE**

Suitable for Kitchen Countertops,  
Backsplashes, Dining Tables,  
Vanities, Feature Walls,  
Bathrooms, Floors and the  
Ventilated Facades.

  
**BIGSLABS**®  
BY  
nuovocorso  
Made in Italy

PREMIUM SINTERED  
STONE MANUFACTURER





# HEAVEN TRAVERTINO TAUPE

---

## SINTERED STONE

### FORMATO / SIZE



**162x324 cm** 64"x127"  
full size (12 mm)

**160x320 cm** 63"x126"  
Rett. Rect. (6,5 mm)

### SPESSORI / THICKNESSES



**6,5 mm** 0.25"  
**12 mm** 0.47"

### FINITURE / FINISHES



**Naturale** Matt  
**Levigato** Polished  
**Honed** Honed

Stuoia disponibile, a pagamento, su richiesta.  
Fiber available upon request, with surcharge.

  
**BIGSLABS**<sup>®</sup>  
BY  
**.nuovocorso**  
Made in Italy

PREMIUM SINTERED  
STONE MANUFACTURER

[www.nuovocorso.sg](http://www.nuovocorso.sg)

**NUOVOCORSO  
SINTERED STONE**

## **HEAVEN TRAVERTINO TIGER**

Suitable for Kitchen Countertops,  
Backsplashes, Dining Tables,  
Vanities, Feature Walls,  
Bathrooms, Floors and the  
Ventilated Facades.

  
**BIGSLABS**®  
BY  
nuovocorso  
Made in Italy

PREMIUM SINTERED  
STONE MANUFACTURER



# HEAVEN TRAVERTINO TIGER

---

## SINTERED STONE

### FORMATO / SIZE



**162x324 cm** 64"x127"  
full size (12 mm)

**160x320 cm** 63"x126"  
Rett. Rect. (6,5 mm)

### SPESSORI / THICKNESSES



**6,5 mm** 0.25"  
**12 mm** 0.47"

### FINITURE / FINISHES



**Naturale** Matt  
**Levigato** Polished  
**Honed** Honed

Stuoia disponibile, a pagamento, su richiesta.  
Fiber available upon request, with surcharge.

  
**BIGSLABS**®  
BY  
**.nuovocorso**  
Made in Italy

PREMIUM SINTERED  
STONE MANUFACTURER

[www.nuovocorso.sg](http://www.nuovocorso.sg)

**NUOVOCORSO  
SINTERED STONE**

## **HEAVEN TRAVERTINO WHITE**

Suitable for Kitchen Countertops,  
Backsplashes, Dining Tables,  
Vanities, Feature Walls,  
Bathrooms, Floors and the  
Ventilated Facades.

  
**BIGSLABS**®  
BY  
nuovocorso  
Made in Italy

PREMIUM SINTERED  
STONE MANUFACTURER





# HEAVEN TRAVERTINO WHITE

---

## SINTERED STONE

### FORMATO / SIZE



**162x324 cm** 64"x127"  
full size (12 mm)

**160x320 cm** 63"x126"  
Rett. Rect. (6,5 mm)

### SPESSORI / THICKNESSES



**6,5 mm** 0.25"  
**12 mm** 0.47"

### FINITURE / FINISHES



**Naturale** Matt  
**Levigato** Polished  
**Honed** Honed

Stuoia disponibile, a pagamento, su richiesta.  
Fiber available upon request, with surcharge.

  
**BIGSLABS**®  
BY  
**.nuovocorso**  
Made in Italy

PREMIUM SINTERED  
STONE MANUFACTURER

[www.nuovocorso.sg](http://www.nuovocorso.sg)

---

## **NUOVOCORSO SINTERED STONE**

---

## **HERMON**

---

Suitable for Kitchen Countertops,  
Backsplashes, Dining Tables,  
Vanities, Feature Walls,  
Bathrooms, Floors and the  
Ventilated Facades.

  
**BIGSLABS**®  
BY  
nuovocorso  
Made in Italy

PREMIUM SINTERED  
STONE MANUFACTURER



# HERMON

## SINTERED STONE

### FORMATO / SIZE



**162x324 cm** 64"x127"  
full size (12 mm)

**160x320 cm** 63"x126"  
Rett. Rect. (6,5 mm)

### SPESSORI / THICKNESSES



**6,5 mm** 0.25"  
**12 mm** 0.47"

### FINITURE / FINISHES



**Naturale** Matt  
**Levigato** Polished

Stuoia disponibile, a pagamento, su richiesta.  
Fiber available upon request, with surcharge.

  
**BIGSLABS**®  
BY  
**.nuovocorso**  
Made in Italy

PREMIUM SINTERED  
STONE MANUFACTURER

[www.nuovocorso.sg](http://www.nuovocorso.sg)

## **NUOVOCORSO SINTERED STONE**

### **IVORY ONYX**

Suitable for Kitchen Countertops,  
Backsplashes, Dining Tables,  
Vanities, Feature Walls,  
Bathrooms, Floors and the  
Ventilated Facades.

  
**BIGSLABS**®  
BY  
**nuovocorso**  
Made in Italy

PREMIUM SINTERED  
STONE MANUFACTURER





# IVORY ONYX

## SINTERED STONE

### FORMATO / SIZE



**162x324 cm** 64"x127"  
full size (12 mm)

**160x320 cm** 63"x126"  
Rett. Rect. (6,5 mm)

### SPESSORI / THICKNESSES



**6,5 mm** 0.25"  
**12 mm** 0.47"

### FINITURE / FINISHES



**Naturale** Matt  
**Levigato** Polished

Stuoia disponibile, a pagamento, su richiesta.  
Fiber available upon request, with surcharge.

  
**BIGSLABS**<sup>®</sup>  
BY  
**.nuovocorso**  
Made in Italy

PREMIUM SINTERED  
STONE MANUFACTURER

---

**NUOVOCORSO  
SINTERED STONE**

---

**JADE**

---

Suitable for Kitchen Countertops,  
Backsplashes, Dining Tables,  
Vanities, Feature Walls,  
Bathrooms, Floors and the  
Ventilated Facades.

  
**BIGSLABS**®  
BY  
**nuovocorso**  
Made in Italy

PREMIUM SINTERED  
STONE MANUFACTURER



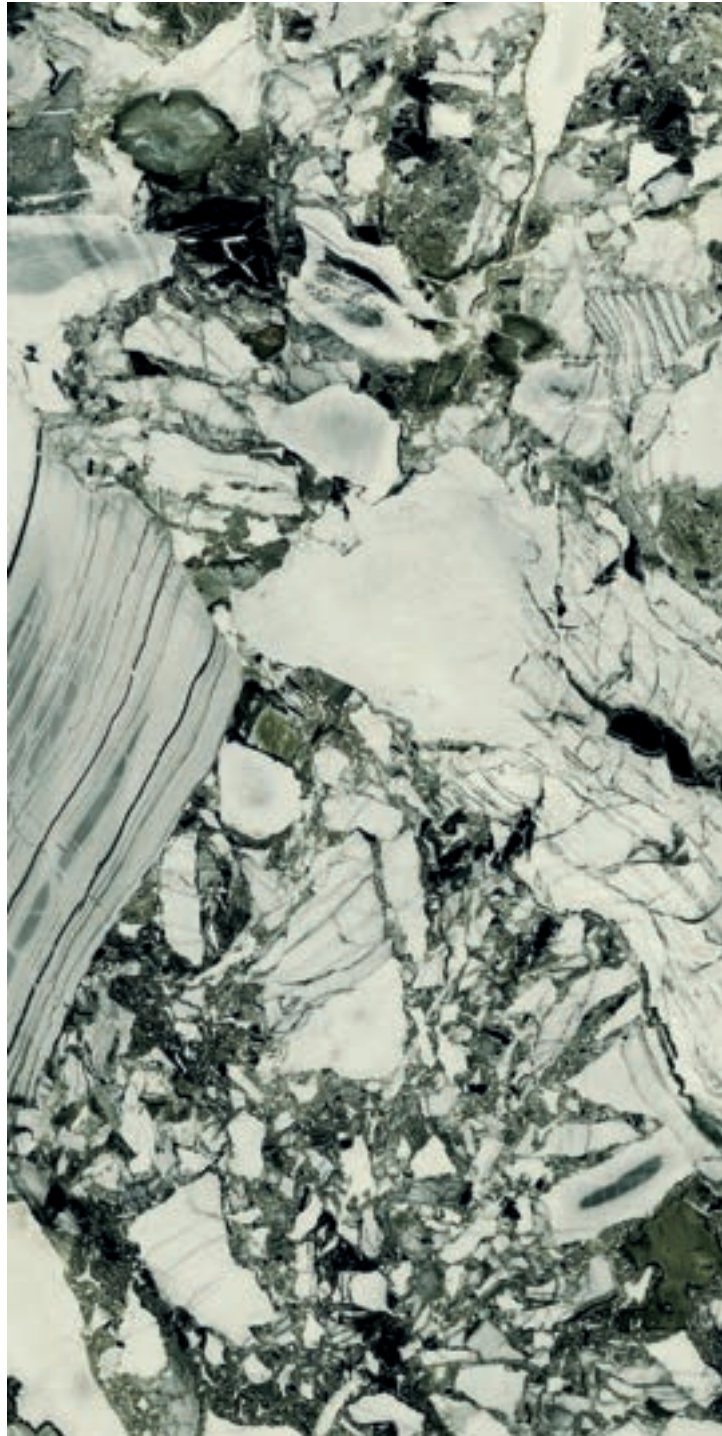
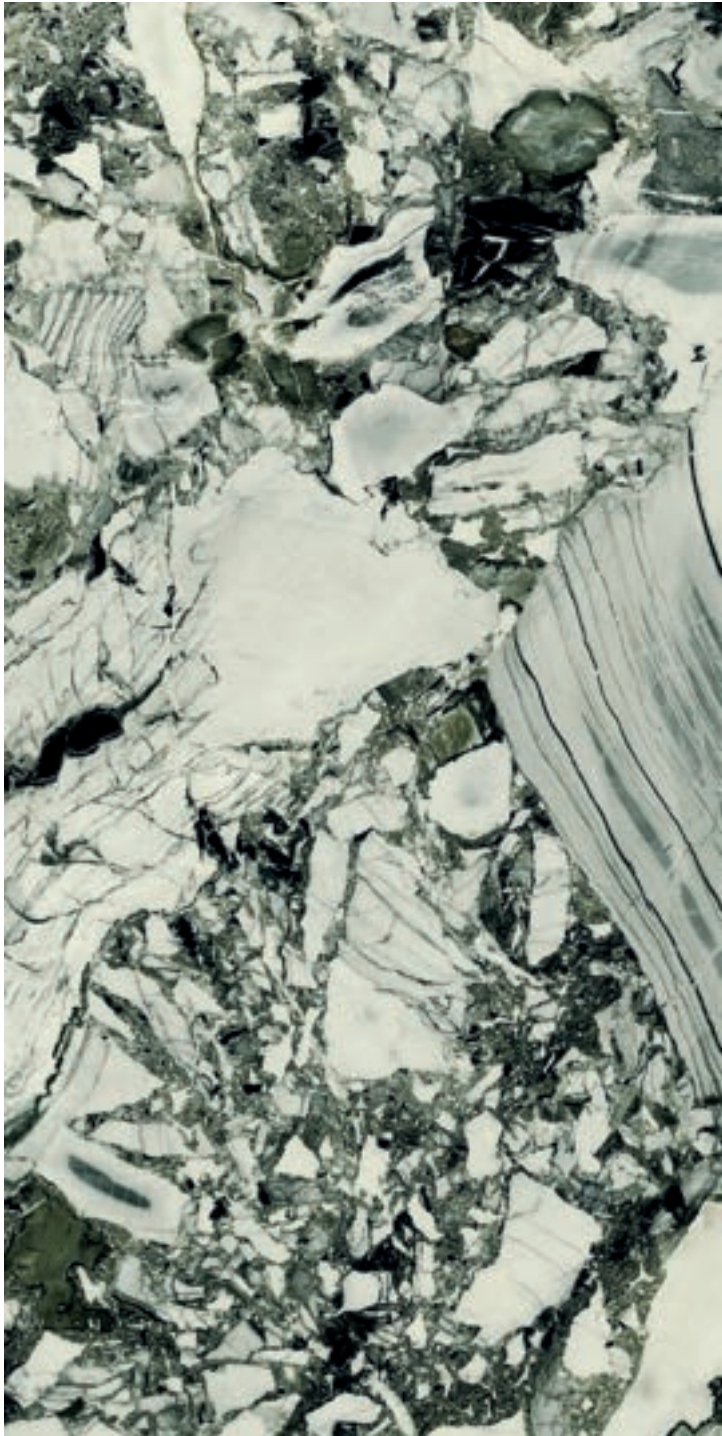

# JADE

## SINTERED STONE

### FORMATO / SIZE



**162x324 cm** 64"x127"  
full size (12 mm)

**160x320 cm** 63"x126"  
Rett. Rect. (6,5 mm)

### SPESSORI / THICKNESSES



**6,5 mm** 0.25"  
**12 mm** 0.47"

### FINITURE / FINISHES



**Levigato** Polished  
**Honed** Honed

Stuoia disponibile, a pagamento, su richiesta.  
Fiber available upon request, with surcharge.

  
**BIGSLABS**®  
BY  
**nuovocorso**  
Made in Italy

PREMIUM SINTERED  
STONE MANUFACTURER

---

**NUOVOCORSO  
SINTERED STONE**

**LASA  
WHITE**

---

**12mm / 2cm**

Suitable for Kitchen Countertops,  
Backsplashes, Dining Tables,  
Vanities, Feature Walls,  
Bathrooms, Floors and the  
Ventilated Facades.

  
**BIGSLABS**®  
BY  
**nuovocorso**  
Made in Italy

PREMIUM SINTERED  
STONE MANUFACTURER





# LASA WHITE

## SINTERED STONE

### FORMATO / SIZE



**162x324 cm** 64"x127"  
full size

### SPESSORI / THICKNESSES



**12 mm** 0.47"  
**2 cm** 0.78"

### FINITURE / FINISHES



**Naturale** Matt  
**Levigato** Polished  
**Honed** Honed

Stuoia disponibile, a pagamento, su richiesta.  
Fiber available upon request, with surcharge.

  
**BIGSLABS**<sup>®</sup>  
BY  
**nuovocorso**  
Made in Italy

PREMIUM SINTERED  
STONE MANUFACTURER

[www.nuovocorso.sg](http://www.nuovocorso.sg)

---

**NUOVOCORSO  
SINTERED STONE**

---

**LASA  
WHITE**

---

**6,5mm**

Suitable for Kitchen Countertops,  
Backsplashes, Dining Tables,  
Vanities, Feature Walls,  
Bathrooms, Floors and the  
Ventilated Facades.

  
**BIGSLABS**®  
BY  
**nuovocorso**  
Made in Italy

PREMIUM SINTERED  
STONE MANUFACTURER



# LASA WHITE

SINTERED STONE

FINITURE / FINISHES

SPESSORI / THICKNESSES

FORMATO / SIZE



**Naturale** Matt  
**Levigato** Polished  
**Honed** Honed



**6,5 mm** 0.25"



**160x320 cm** 63"x126"  
**Rett. Rect.**

Stuoia disponibile, a pagamento, su richiesta.  
Fiber available upon request, with surcharge.



PREMIUM SINTERED  
STONE MANUFACTURER

[www.nuovocorso.sg](http://www.nuovocorso.sg)

**NUOVOCORSO  
SINTERED STONE**

## **LIGHT RED CALACATTA**

Suitable for Kitchen Countertops,  
Backsplashes, Dining Tables,  
Vanities, Feature Walls,  
Bathrooms, Floors and the  
Ventilated Facades.

  
**BIGSLABS**®  
BY  
nuovocorso  
Made in Italy

PREMIUM SINTERED  
STONE MANUFACTURER





# LIGHT RED CALACATTA

SINTERED STONE

## FORMATO / SIZE



**162x324 cm** 64"x127"  
full size (12 mm / 2 cm)

**160x320 cm** 63"x126"  
Rett. Rect. (6,5 mm)

## SPESSORI / THICKNESSES



**6,5 mm** 0.25"  
**12 mm** 0.47"  
**2 cm** 0.78"

## FINITURE / FINISHES



**Naturale** Matt  
**Levigato** Polished  
**Honed** Honed

Stuoia disponibile, a pagamento, su richiesta.  
Fiber available upon request, with surcharge.

  
**BIGSLABS**®  
BY  
**.nuovocorso**  
Made in Italy

PREMIUM SINTERED  
STONE MANUFACTURER

[www.nuovocorso.sg](http://www.nuovocorso.sg)

**NUOVOCORSO  
SINTERED STONE**

**MACCHIA  
VECCHIA  
AZZURRA**

Suitable for Kitchen Countertops,  
Backsplashes, Dining Tables,  
Vanities, Feature Walls,  
Bathrooms, Floors and the  
Ventilated Facades.

  
**BIGSLABS**®  
BY  
nuovocorso  
Made in Italy

PREMIUM SINTERED  
STONE MANUFACTURER





# MACCHIA VECCHIA AZZURRA

SINTERED STONE

## FORMATO / SIZE



**162x324 cm** 64"x127"  
full size (12 mm)

**160x320 cm** 63"x126"  
Rett. Rect. (6,5 mm)

## SPESSORI / THICKNESSES



**6,5 mm** 0.25"  
**12 mm** 0.47"

## FINITURE / FINISHES



**Naturale** Matt  
**Levigato** Polished

Stuoia disponibile, a pagamento, su richiesta.  
Fiber available upon request, with surcharge.

  
**BIGSLABS**®  
BY  
**nuovocorso**  
Made in Italy

PREMIUM SINTERED  
STONE MANUFACTURER

[www.nuovocorso.sg](http://www.nuovocorso.sg)

**NUOVOCORSO  
SINTERED STONE**

## **MARCAUBAS BEIGE**

Suitable for Kitchen Countertops,  
Backsplashes, Dining Tables,  
Vanities, Feature Walls,  
Bathrooms, Floors and the  
Ventilated Facades.

  
**BIGSLABS**<sup>®</sup>  
BY  
**nuovocorso**  
Made in Italy

PREMIUM SINTERED  
STONE MANUFACTURER



# MARCAUBAS BEIGE

SINTERED STONE

## FORMATO / SIZE



**162x324 cm** 64"x127"  
full size (12 mm)

**160x320 cm** 63"x126"  
Rett. Rect. (6,5 mm)

## SPESSORI / THICKNESSES



**6,5 mm** 0.25"  
**12 mm** 0.47"

## FINITURE / FINISHES



**Naturale Matt**

### ART 5D TECHNOLOGY SURFACE

Finishing, which combines on the same slab glossy and matt areas. The matt areas can have a satin or structured finish, for a pleasant and unusual tactile sensation.

  
BY  
**nuovocorso**  
Made in Italy

PREMIUM SINTERED  
STONE MANUFACTURER

[www.nuovocorso.sg](http://www.nuovocorso.sg)

**NUOVOCORSO  
SINTERED STONE**

## **MARCAUBAS IVORY**

Suitable for Kitchen Countertops,  
Backsplashes, Dining Tables,  
Vanities, Feature Walls,  
Bathrooms, Floors and the  
Ventilated Facades.

  
**BIGSLABS**®  
BY  
nuovocorso  
Made in Italy

PREMIUM SINTERED  
STONE MANUFACTURER



# MARCAUBAS IVORY

SINTERED STONE

## FORMATO / SIZE



**162x324 cm** 64"x127"  
full size (12 mm)

**160x320 cm** 63"x126"  
Rett. Rect. (6,5 mm)

## SPESSORI / THICKNESSES



**6,5 mm** 0.25"  
**12 mm** 0.47"

## FINITURE / FINISHES



**Naturale Matt**

ART 5D TECHNOLOGY SURFACE

Finishing, which combines on the same slab glossy and matt areas. The matt areas can have a satin or structured finish, for a pleasant and unusual tactile sensation.

  
**BIGSLABS**®  
BY  
**nuovocorso**  
Made in Italy

PREMIUM SINTERED  
STONE MANUFACTURER

[www.nuovocorso.sg](http://www.nuovocorso.sg)

**NUOVOCORSO  
SINTERED STONE**

## **MARCAUBAS WHITE**

Suitable for Kitchen Countertops,  
Backsplashes, Dining Tables,  
Vanities, Feature Walls,  
Bathrooms, Floors and the  
Ventilated Facades.

  
**BIGSLABS**®  
BY  
**nuovocorso**  
Made in Italy

PREMIUM SINTERED  
STONE MANUFACTURER





# MARCAUBAS WHITE

SINTERED STONE

## FORMATO / SIZE



**162x324 cm** 64"x127"  
full size (12 mm)

**160x320 cm** 63"x126"  
Rett. Rect. (6,5 mm)

## SPESSORI / THICKNESSES



**6,5 mm** 0.25"  
**12 mm** 0.47"

## FINITURE / FINISHES



**Naturale Matt**

ART 5D TECHNOLOGY SURFACE

Finishing, which combines on the same slab glossy and matt areas. The matt areas can have a satin or structured finish, for a pleasant and unusual tactile sensation.

  
**BIGSLABS**<sup>®</sup>  
BY  
**nuovocorso**  
Made in Italy

PREMIUM SINTERED  
STONE MANUFACTURER

[www.nuovocorso.sg](http://www.nuovocorso.sg)

**NUOVOCORSO  
SINTERED STONE**

## **MARMO ANTICO**

Suitable for Kitchen Countertops,  
Backsplashes, Dining Tables,  
Vanities, Feature Walls,  
Bathrooms, Floors and the  
Ventilated Facades.

  
**BIGSLABS**®  
BY  
nuovocorso  
Made in Italy

PREMIUM SINTERED  
STONE MANUFACTURER





# MARMO ANTICO

---

## SINTERED STONE

### FORMATO / SIZE



**162x324 cm** 64"x127"  
full size (12 mm / 2 cm)

**160x320 cm** 63"x126"  
Rett. Rect. (6,5 mm)

### SPESSORI / THICKNESSES



**6,5 mm** 0.25"  
**12 mm** 0.47"  
**2 cm** 0.78"

### FINITURE / FINISHES



**Naturale** Matt  
**Levigato** Polished  
**Honed** Honed

Stuoia disponibile, a pagamento, su richiesta.  
Fiber available upon request, with surcharge.

  
**BIGSLABS**®  
BY  
**.nuovocorso**  
Made in Italy

PREMIUM SINTERED  
STONE MANUFACTURER

[www.nuovocorso.sg](http://www.nuovocorso.sg)

---

**NUOVOCORSO  
SINTERED STONE**

---

**MASADA**

---

Suitable for Kitchen Countertops,  
Backsplashes, Dining Tables,  
Vanities, Feature Walls,  
Bathrooms, Floors and the  
Ventilated Facades.

  
**BIGSLABS**®  
BY  
  
Made in Italy

PREMIUM SINTERED  
STONE MANUFACTURER





# MASADA

## SINTERED STONE

### FORMATO / SIZE



**162x324 cm** 64"x127"  
full size

### SPESSORI / THICKNESSES



**12 mm** 0.47"

### FINITURE / FINISHES



**Naturale Matt**

Stuoia disponibile, a pagamento, su richiesta.  
Fiber available upon request, with surcharge.

  
**BIGSLABS**<sup>®</sup>  
BY  
**nuovocorso**  
Made in Italy

PREMIUM SINTERED  
STONE MANUFACTURER



[www.nuovocorso.sg](http://www.nuovocorso.sg)

---

## **NUOVOCORSO SINTERED STONE**

---

## **MERAKI**

---

Suitable for Kitchen Countertops,  
Backsplashes, Dining Tables,  
Vanities, Feature Walls,  
Bathrooms, Floors and the  
Ventilated Facades.

  
**BIGSLABS**®  
BY  
nuovocorso  
Made in Italy

PREMIUM SINTERED  
STONE MANUFACTURER



# MERAKI

## SINTERED STONE

### FORMATO / SIZE



**162x324 cm** 64"x127"  
full size (12 mm / 2 cm)

**160x320 cm** 63"x126"  
 **Rett. Rect.** (6,5 mm)

### SPESSORI / THICKNESSES



**6,5 mm** 0.25"  
**12 mm** 0.47"  
**2 cm** 0.78"

### FINITURE / FINISHES



**Naturale Matt**  
**Levigato Polished**

Stuoia disponibile, a pagamento, su richiesta.  
Fiber available upon request, with surcharge.

  
**BIGSLABS**<sup>®</sup>  
BY  
**.nuovocorso**  
Made in Italy

PREMIUM SINTERED  
STONE MANUFACTURER

[www.nuovocorso.sg](http://www.nuovocorso.sg)

---

**NUOVOCORSO  
SINTERED STONE**

---

**MONET**

---

Suitable for Kitchen Countertops,  
Backsplashes, Dining Tables,  
Vanities, Feature Walls,  
Bathrooms, Floors and the  
Ventilated Facades.



  
**BIGSLABS**<sup>®</sup>  
BY  
**nuovocorso**  
Made in Italy

PREMIUM SINTERED  
STONE MANUFACTURER

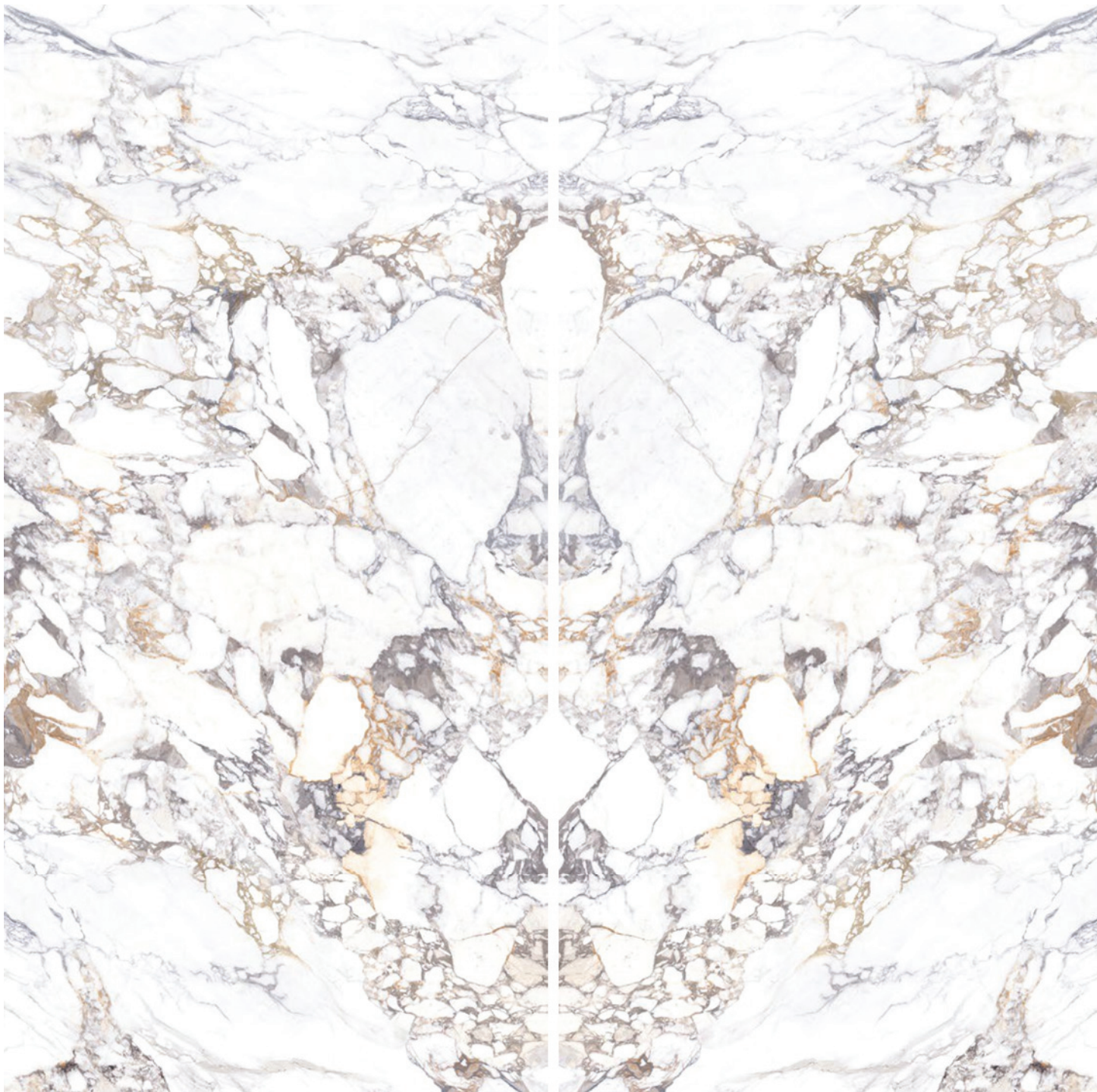

# MONET

## SINTERED STONE

### FORMATO / SIZE



**162x324 cm** 64"x127"  
full size (12 mm)

**160x320 cm** 63"x126"  
 **Rett. Rect.** (6,5 mm)

### SPESSORI / THICKNESSES



**6,5 mm** 0.25"  
**12 mm** 0.47"

### FINITURE / FINISHES



**Naturale** Matt  
**Levigato** Polished  
**Honed** Honed

### ART 5D TECHNOLOGY SURFACE

Finishing, which combines on the same slab glossy and matt areas. The matt areas can have a satin or structured finish, for a pleasant and unusual tactile sensation.

  
**BIGSLABS**®  
BY  
**nuovocorso**  
Made in Italy

PREMIUM SINTERED  
STONE MANUFACTURER

[www.nuovocorso.sg](http://www.nuovocorso.sg)

**NUOVOCORSO  
SINTERED STONE**

## **MONTE BIANCO**

Suitable for Kitchen Countertops,  
Backsplashes, Dining Tables,  
Vanities, Feature Walls,  
Bathrooms, Floors and the  
Ventilated Facades.

  
**BIGSLABS**®  
BY  
**nuovocorso**  
Made in Italy

PREMIUM SINTERED  
STONE MANUFACTURER





# MONTE BIANCO

---

## SINTERED STONE

### FORMATO / SIZE



**162x324 cm** 64"x127"  
full size (12 mm / 2 cm)

**160x320 cm** 63"x126"  
Rett. Rect. (6,5 mm)

### SPESSORI / THICKNESSES



**6,5 mm** 0.25"  
**12 mm** 0.47"  
**2 cm** 0.78"

### FINITURE / FINISHES



**Naturale** Matt  
**Levigato** Polished

Stuoia disponibile, a pagamento, su richiesta.  
Fiber available upon request, with surcharge.

  
**BIGSLABS**<sup>®</sup>  
BY  
**nuovocorso**  
Made in Italy

PREMIUM SINTERED  
STONE MANUFACTURER

[www.nuovocorso.sg](http://www.nuovocorso.sg)

**NUOVOCORSO  
SINTERED STONE**

## **NAVONA CLASSICO**

Suitable for Kitchen Countertops,  
Backsplashes, Dining Tables,  
Vanities, Feature Walls,  
Bathrooms, Floors and the  
Ventilated Facades.

  
**BIGSLABS**®  
BY  
nuovocorso  
Made in Italy

PREMIUM SINTERED  
STONE MANUFACTURER

# NAVONA CLASSICO

SINTERED STONE

## FORMATO / SIZE



**162x324 cm** 64"x127"  
full size (12 mm)

**160x320 cm** 63"x126"  
**Rett.** Rect. (6,5 mm)

## SPESSORI / THICKNESSES



**6,5 mm** 0.25"  
**12 mm** 0.47"

## FINITURE / FINISHES



**Naturale** Matt  
**Honed** Honed

Stuoia disponibile, a pagamento, su richiesta.  
Fiber available upon request, with surcharge.

  
**BIGSLABS**<sup>®</sup>  
BY  
**nuovocorso**  
Made in Italy

PREMIUM SINTERED  
STONE MANUFACTURER

[www.nuovocorso.sg](http://www.nuovocorso.sg)

**NUOVOCORSO  
SINTERED STONE**

**NERO  
MARQUINA**

**12mm**

Suitable for Kitchen Countertops,  
Backsplashes, Dining Tables,  
Vanities, Feature Walls,  
Bathrooms, Floors and the  
Ventilated Facades.

  
**BIGSLABS**®  
BY  
**nuovocorso**  
Made in Italy

PREMIUM SINTERED  
STONE MANUFACTURER





# NERO MARQUINA

---

## SINTERED STONE

### FORMATO / SIZE



**162x324 cm** 64"x127"  
full size

### SPESSORI / THICKNESSES



**12 mm** 0.47"

### FINITURE / FINISHES



**Naturale Matt**  
**Levigato Polished**

Stuoia disponibile, a pagamento, su richiesta.  
Fiber available upon request, with surcharge.

  
**BIGSLABS**®  
BY  
**nuovocorso**  
Made in Italy

PREMIUM SINTERED  
STONE MANUFACTURER

[www.nuovocorso.sg](http://www.nuovocorso.sg)

**NUOVOCORSO  
SINTERED STONE**

**NERO  
MARQUINA**

**6,5mm**

Suitable for Kitchen Countertops,  
Backsplashes, Dining Tables,  
Vanities, Feature Walls,  
Bathrooms, Floors and the  
Ventilated Facades.

  
**BIGSLABS**®  
BY  
**nuovocorso**  
Made in Italy

PREMIUM SINTERED  
STONE MANUFACTURER



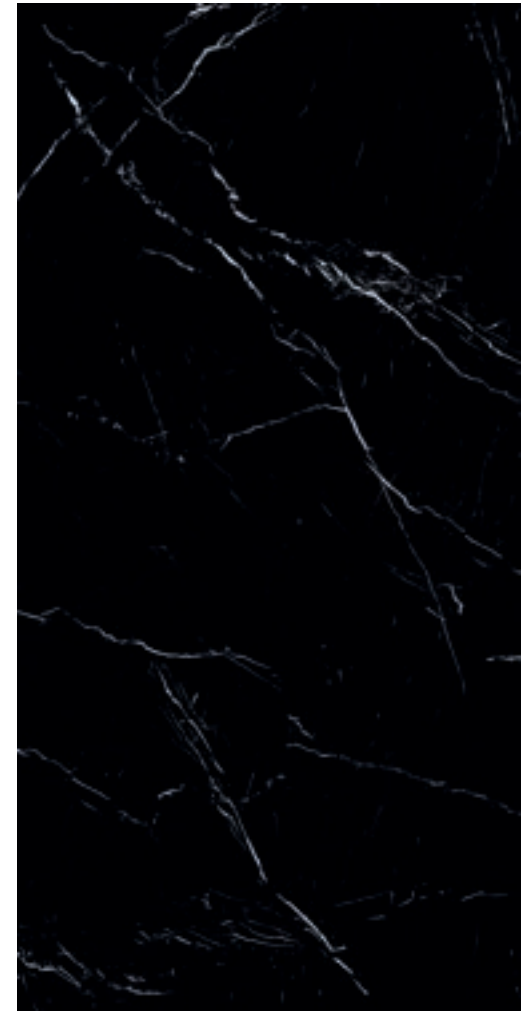
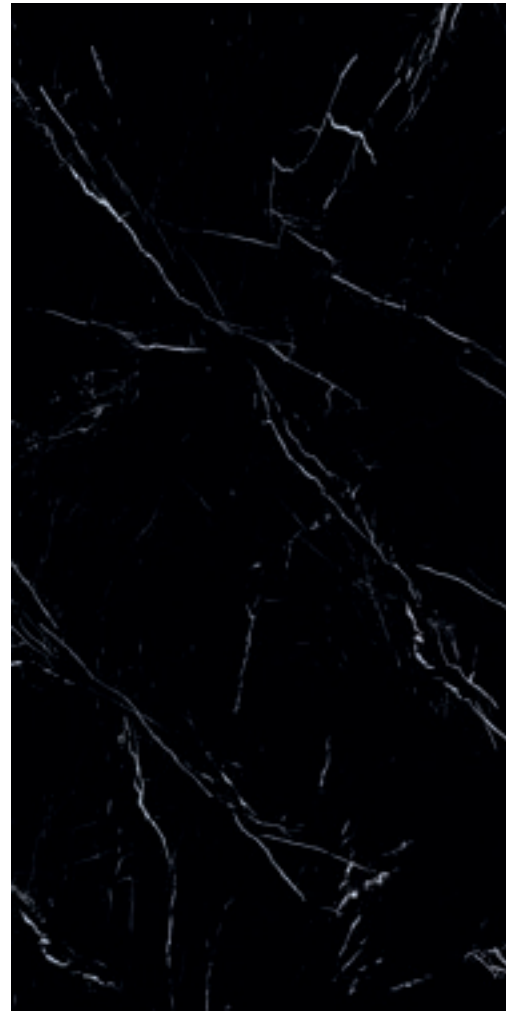
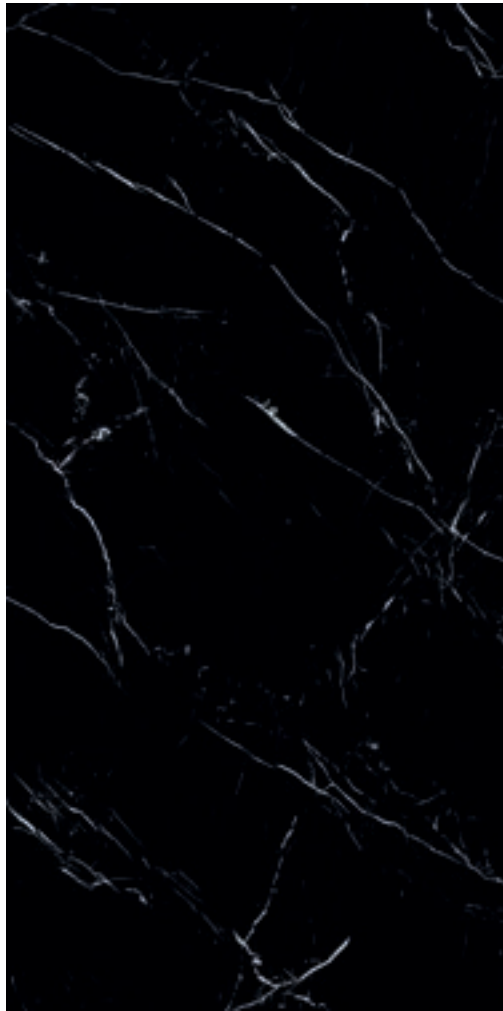

# NERO MARQUINA

SINTERED STONE

FINITURE / FINISHES

SPESSORI / THICKNESSES

FORMATO / SIZE



**Naturale Matt**  
**Levigato Polished**



**6,5 mm 0.25"**



**160x320 cm 63"x126"**  
**Rett. Rect.**

Stuoia disponibile, a pagamento, su richiesta.  
Fiber available upon request, with surcharge.



PREMIUM SINTERED  
STONE MANUFACTURER

[www.nuovocorso.sg](http://www.nuovocorso.sg)

---

**NUOVOCORSO  
SINTERED STONE**

---

**ONICE  
COBALTO**

---

Suitable for Kitchen Countertops,  
Backsplashes, Dining Tables,  
Vanities, Feature Walls,  
Bathrooms, Floors and the  
Ventilated Facades.

  
**BIGSLABS**®  
BY  
nuovocorso  
Made in Italy

PREMIUM SINTERED  
STONE MANUFACTURER



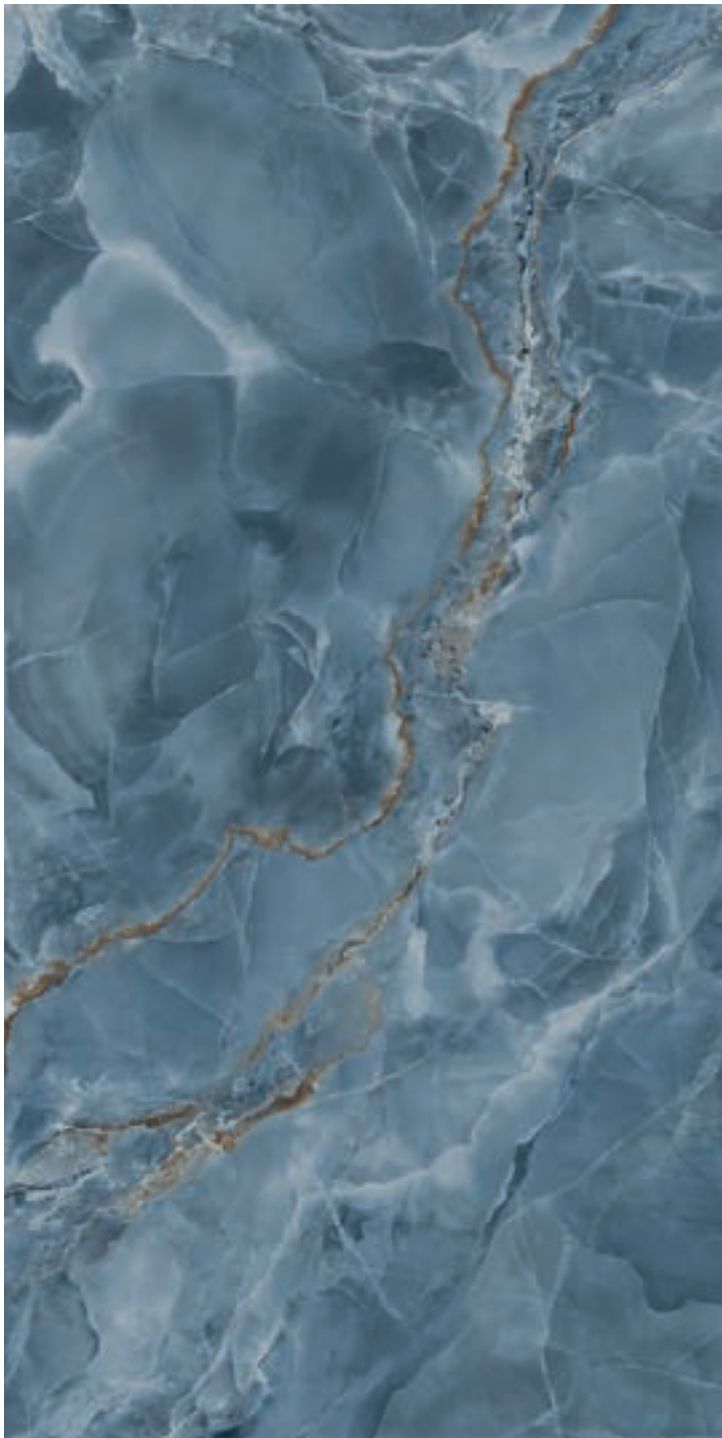

# ONICE COBALTO

## SINTERED STONE

### FORMATO / SIZE



**162x324 cm** 64"x127"  
full size (12 mm)

**160x320 cm** 63"x126"  
Rett. Rect. (6,5 mm)

### SPESSORI / THICKNESSES



**6,5 mm** 0.25"  
**12 mm** 0.47"

### FINITURE / FINISHES



**Levigato** Polished

Stuoia disponibile, a pagamento, su richiesta.  
Fiber available upon request, with surcharge.

  
**BIGSLABS**<sup>®</sup>  
BY  
**.nuovocorso**  
Made in Italy

PREMIUM SINTERED  
STONE MANUFACTURER

[www.nuovocorso.sg](http://www.nuovocorso.sg)

**NUOVOCORSO  
SINTERED STONE**

## **ONICE NERO**

Suitable for Kitchen Countertops,  
Backsplashes, Dining Tables,  
Vanities, Feature Walls,  
Bathrooms, Floors and the  
Ventilated Facades.

  
**BIGSLABS**®  
BY  
nuovocorso  
Made in Italy

PREMIUM SINTERED  
STONE MANUFACTURER

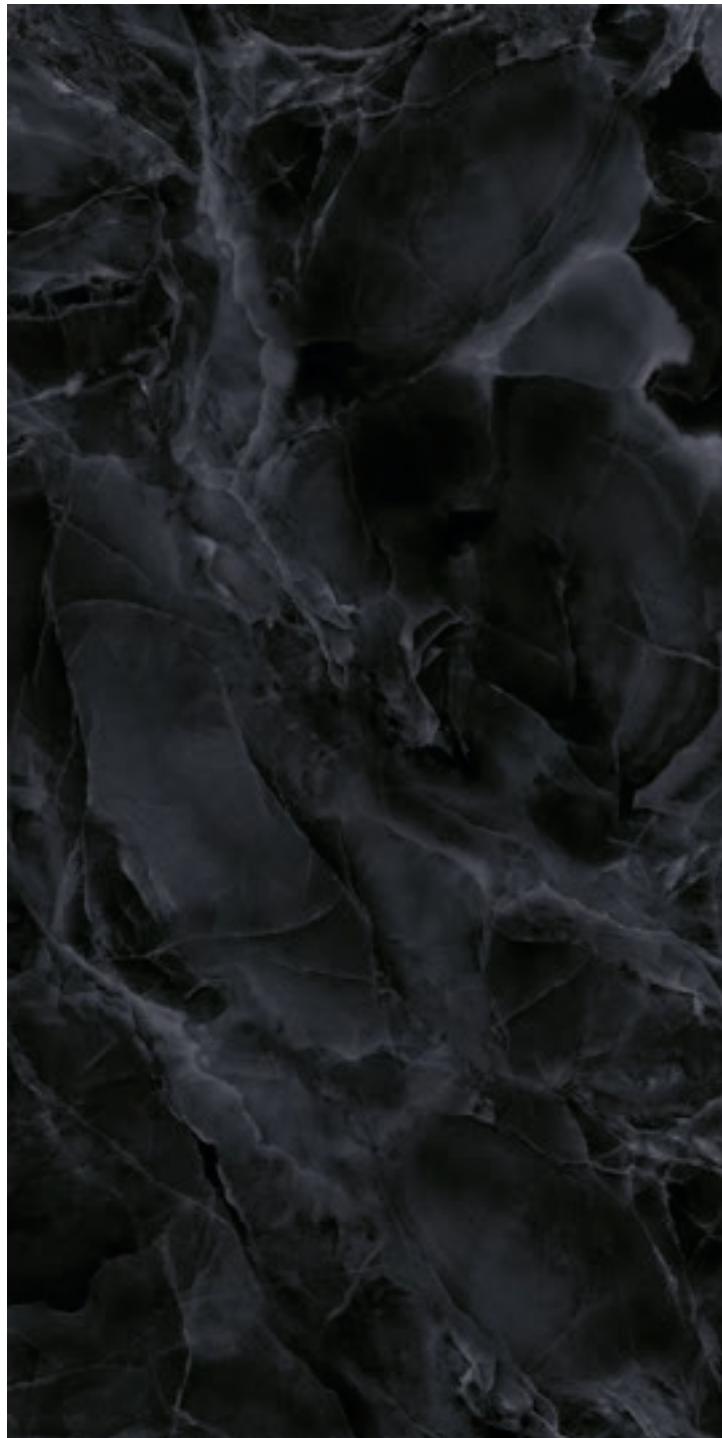
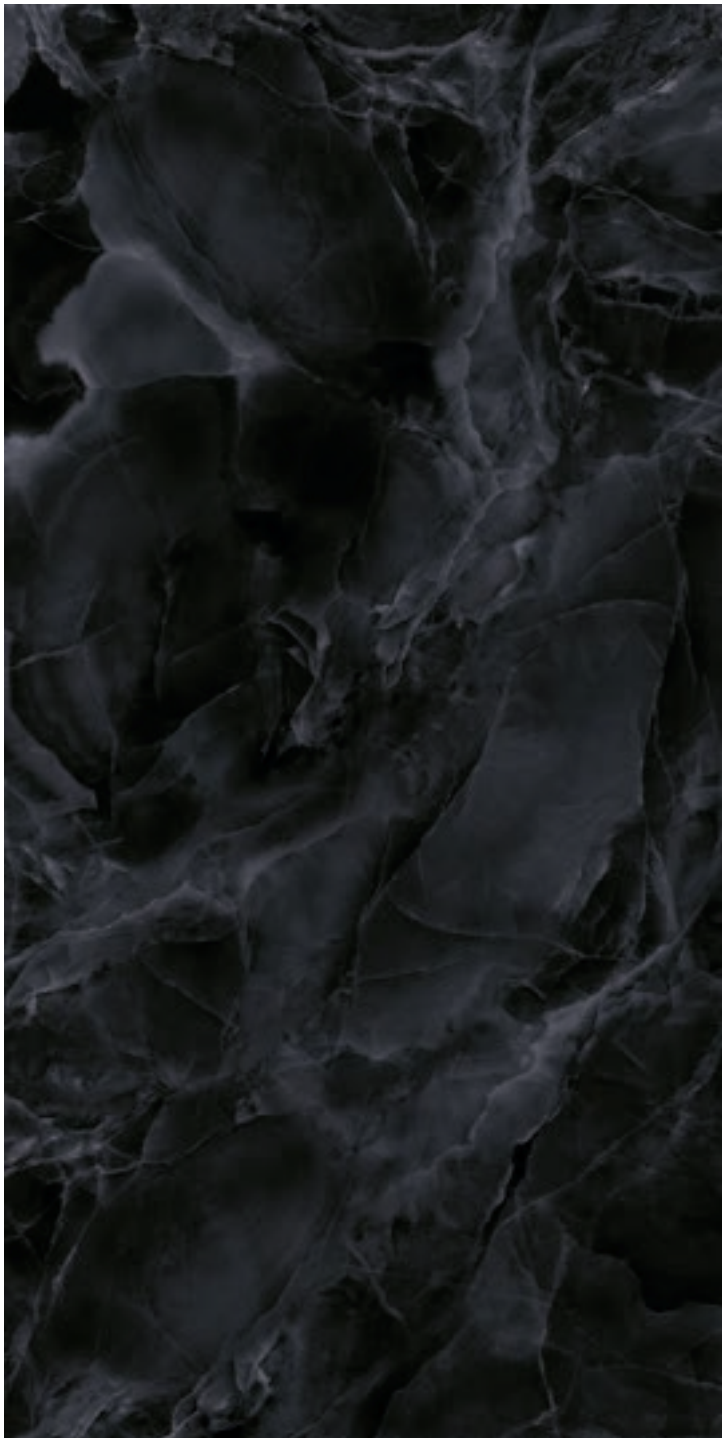

# ONICE NERO

## SINTERED STONE

### FORMATO / SIZE



**162x324 cm** 64"x127"  
full size (12 mm)

**160x320 cm** 63"x126"  
Rett. Rect. (6,5 mm)

### SPESSORI / THICKNESSES



**6,5 mm** 0.25"  
**12 mm** 0.47"

### FINITURE / FINISHES



**Levigato** Polished

Stuoia disponibile, a pagamento, su richiesta.  
Fiber available upon request, with surcharge.

  
**BIGSLABS**<sup>®</sup>  
BY  
**.nuovocorso**  
Made in Italy

PREMIUM SINTERED  
STONE MANUFACTURER

[www.nuovocorso.sg](http://www.nuovocorso.sg)

**NUOVOCORSO  
SINTERED STONE**

## **ONICE SMERALDO**

Suitable for Kitchen Countertops,  
Backsplashes, Dining Tables,  
Vanities, Feature Walls,  
Bathrooms, Floors and the  
Ventilated Facades.

  
**BIGSLABS**®  
BY  
nuovocorso  
Made in Italy

PREMIUM SINTERED  
STONE MANUFACTURER



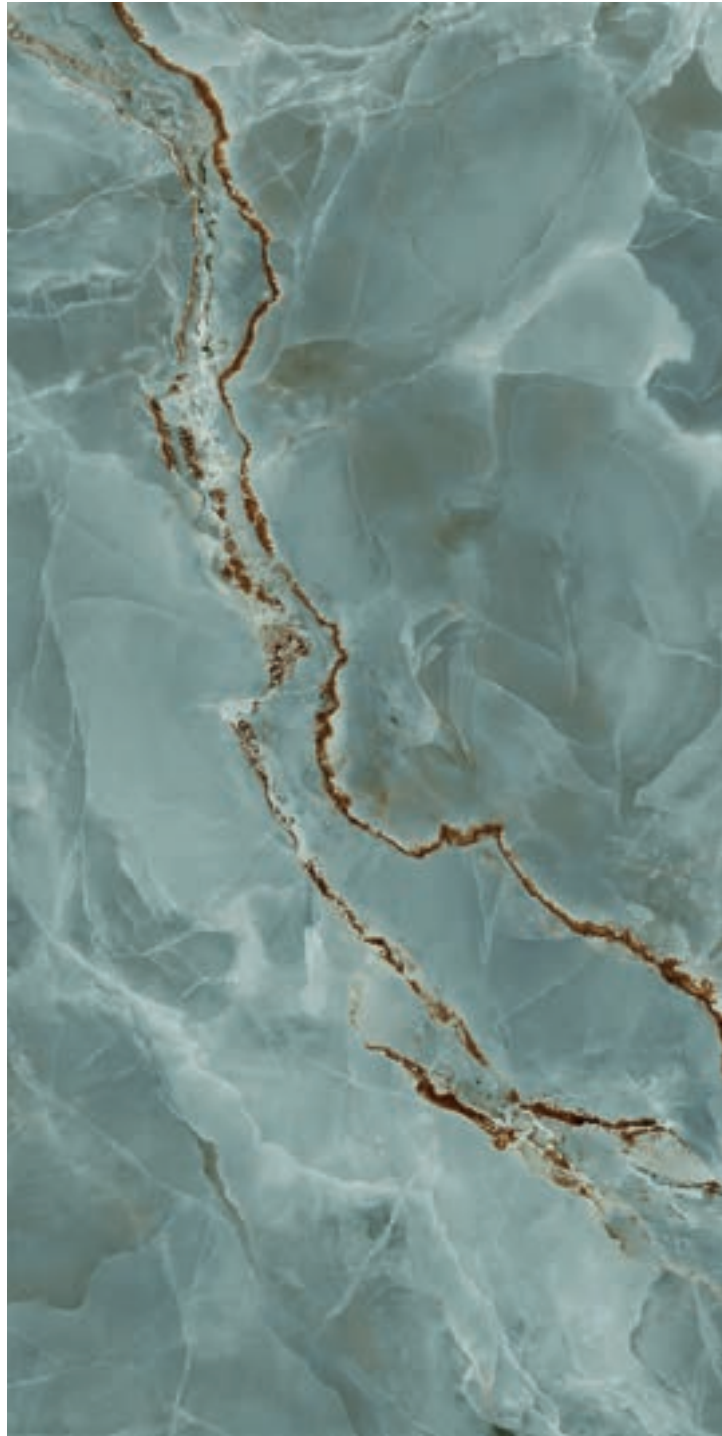
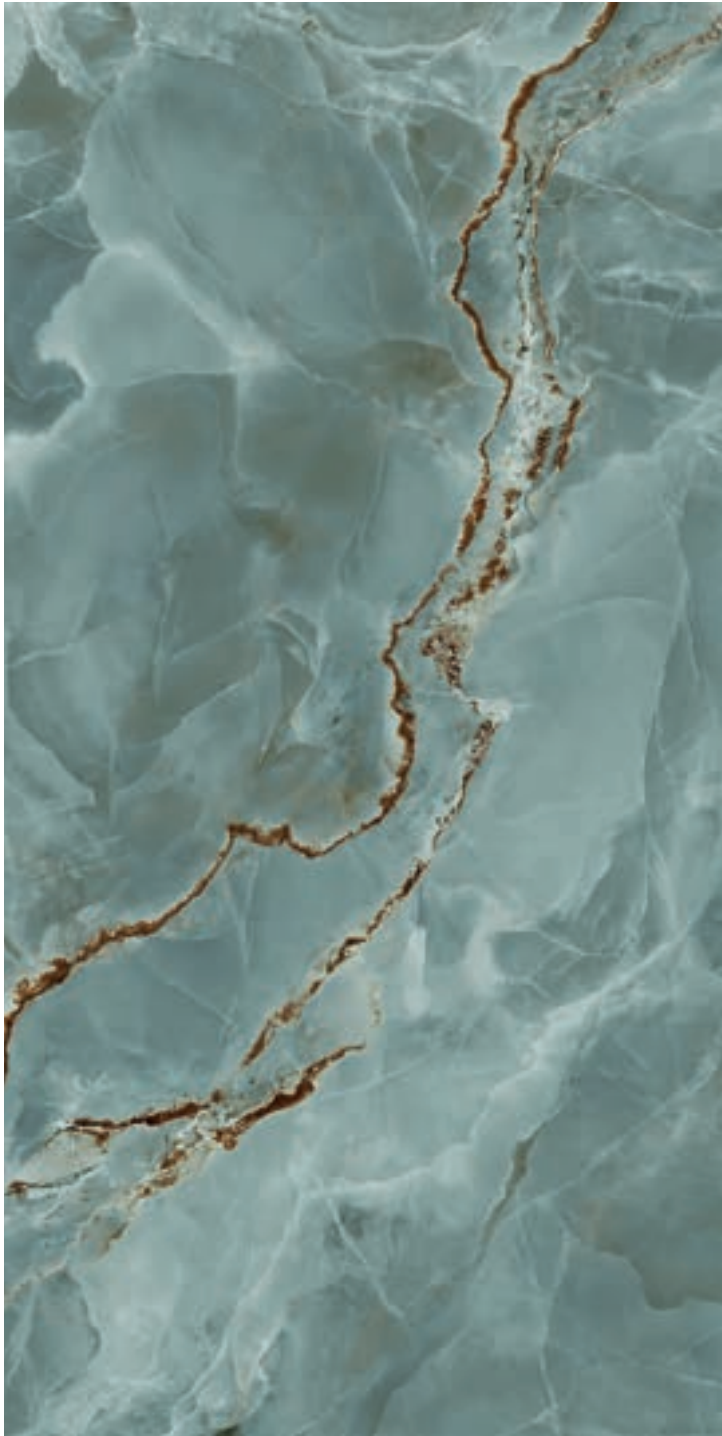

# ONICE SMERALDO

## SINTERED STONE

### FORMATO / SIZE



**162x324 cm** 64"x127"  
full size (12 mm)

**160x320 cm** 63"x126"  
Rett. Rect. (6,5 mm)

### SPESSORI / THICKNESSES



**6,5 mm** 0.25"  
**12 mm** 0.47"

### FINITURE / FINISHES



**Levigato** Polished

Stuoia disponibile, a pagamento, su richiesta.  
Fiber available upon request, with surcharge.

  
**BIGSLABS**<sup>®</sup>  
BY  
**.nuovocorso**  
Made in Italy

PREMIUM SINTERED  
STONE MANUFACTURER

[www.nuovocorso.sg](http://www.nuovocorso.sg)

---

**NUOVOCORSO  
SINTERED STONE**

---

**ORANGE  
SAPPHIRE**

---

Suitable for Kitchen Countertops,  
Backsplashes, Dining Tables,  
Vanities, Feature Walls,  
Bathrooms, Floors and the  
Ventilated Facades.

  
**BIGSLABS**®  
BY  
nuovocorso  
Made in Italy

PREMIUM SINTERED  
STONE MANUFACTURER





# ORANGE SAPPHIRE

## SINTERED STONE

### FORMATO / SIZE



**162x324 cm** 64"x127"  
full size (12 mm)

**160x320 cm** 63"x126"  
Rett. Rect. (6,5 mm)

### SPESSORI / THICKNESSES



**6,5 mm** 0.25"  
**12 mm** 0.47"

### FINITURE / FINISHES



**Levigato** Polished

Stuoia disponibile, a pagamento, su richiesta.  
Fiber available upon request, with surcharge.

  
**BIGSLABS**<sup>®</sup>  
BY  
**.nuovocorso**  
Made in Italy

PREMIUM SINTERED  
STONE MANUFACTURER

[www.nuovocorso.sg](http://www.nuovocorso.sg)

---

**NUOVOCORSO  
SINTERED STONE**

---

**OROBICO**

Suitable for Kitchen Countertops,  
Backsplashes, Dining Tables,  
Vanities, Feature Walls,  
Bathrooms, Floors and the  
Ventilated Facades.

  
**BIGSLABS**®  
BY  
**nuovocorso**  
Made in Italy

PREMIUM SINTERED  
STONE MANUFACTURER



# OROBICO

## SINTERED STONE

### FORMATO / SIZE



**162x324 cm** 64"x127"  
full size (12 mm)

**160x320 cm** 63"x126"  
Rett. Rect. (6,5 mm)

### SPESSORI / THICKNESSES



**6,5 mm** 0.25"  
**12 mm** 0.47"

### FINITURE / FINISHES



**Naturale** Matt  
**Levigato** Polished  
**Honed** Honed

Stuoia disponibile, a pagamento, su richiesta.  
Fiber available upon request, with surcharge.

  
**BIGSLABS**®  
BY  
**.nuovocorso**  
Made in Italy

PREMIUM SINTERED  
STONE MANUFACTURER

[www.nuovocorso.sg](http://www.nuovocorso.sg)

**NUOVOCORSO  
SINTERED STONE**

## **PAONAZZETTO REALE**

Suitable for Kitchen Countertops,  
Backsplashes, Dining Tables,  
Vanities, Feature Walls,  
Bathrooms, Floors and the  
Ventilated Facades.

  
**BIGSLABS**®  
BY  
**nuovocorso**  
Made in Italy

PREMIUM SINTERED  
STONE MANUFACTURER



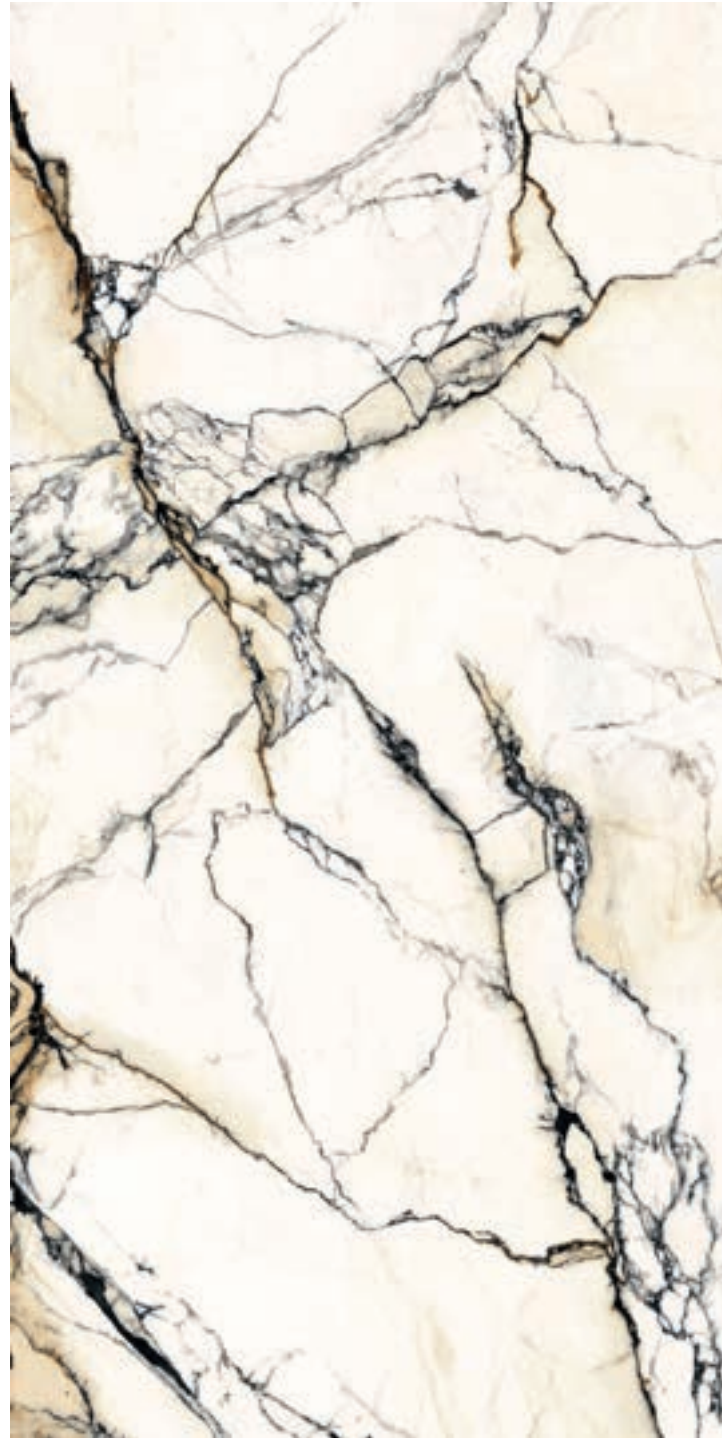

# PAONAZZETTO REALE

SINTERED STONE

## FORMATO / SIZE



**162x324 cm** 64"x127"  
full size (12 mm / 2 cm)

**160x320 cm** 63"x126"  
Rett. Rect. (6,5 mm)

## SPESSORI / THICKNESSES



**6,5 mm** 0.25"  
**12 mm** 0.47"  
**2 cm** 0.78"

## FINITURE / FINISHES



**Naturale** Matt  
**Levigato** Polished  
**Honed** Honed

Stuoia disponibile, a pagamento, su richiesta.  
Fiber available upon request, with surcharge.

  
**BIGSLABS**<sup>®</sup>  
BY  
**.nuovocorso**  
Made in Italy

PREMIUM SINTERED  
STONE MANUFACTURER

[www.nuovocorso.sg](http://www.nuovocorso.sg)

---

**NUOVOCORSO  
SINTERED STONE**

---

**PIETRA  
BROWN**

---

Suitable for Kitchen Countertops,  
Backsplashes, Dining Tables,  
Vanities, Feature Walls,  
Bathrooms, Floors and the  
Ventilated Facades.

  
**BIGSLABS**®  
BY  
nuovocorso  
Made in Italy

PREMIUM SINTERED  
STONE MANUFACTURER





# PIETRA BROWN

SINTERED STONE

## FORMATO / SIZE



**162x324 cm** 64"x127"  
full size

## SPESSORI / THICKNESSES



**12 mm** 0.47"

## FINITURE / FINISHES



**Naturale Matt**  
**Levigato Polished**

Stuoia disponibile, a pagamento, su richiesta.  
Fiber available upon request, with surcharge.

  
BY  
**.nuovocorso**  
Made in Italy

PREMIUM SINTERED  
STONE MANUFACTURER

[www.nuovocorso.sg](http://www.nuovocorso.sg)

**NUOVOCORSO  
SINTERED STONE**

**PIETRA  
GRIGIA**

**12mm**

Suitable for Kitchen Countertops,  
Backsplashes, Dining Tables,  
Vanities, Feature Walls,  
Bathrooms, Floors and the  
Ventilated Facades.

  
**BIGSLABS**®  
BY  
**nuovocorso**  
Made in Italy

PREMIUM SINTERED  
STONE MANUFACTURER



# PIETRA GRIGIA

---

## SINTERED STONE

### FORMATO / SIZE



**162x324 cm** 64"x127"  
full size

### SPESSORI / THICKNESSES



**12 mm** 0.47"

### FINITURE / FINISHES



**Naturale Matt**  
**Levigato Polished**

Stuoia disponibile, a pagamento, su richiesta.  
Fiber available upon request, with surcharge.

  
**BIGSLABS**<sup>®</sup>  
BY  
**nuovocorso**  
Made in Italy

PREMIUM SINTERED  
STONE MANUFACTURER

[www.nuovocorso.sg](http://www.nuovocorso.sg)

---

**NUOVOCORSO  
SINTERED STONE**

---

**PIETRA  
GRIGIA**

---

**6,5mm**

Suitable for Kitchen Countertops,  
Backsplashes, Dining Tables,  
Vanities, Feature Walls,  
Bathrooms, Floors and the  
Ventilated Facades.

  
**BIGSLABS**®  
BY  
**nuovocorso**  
Made in Italy

PREMIUM SINTERED  
STONE MANUFACTURER



# PIETRA GRIGIA

SINTERED STONE

FINITURE / FINISHES

SPESSORI / THICKNESSES

FORMATO / SIZE



**Naturale Matt**  
**Levigato Polished**



**6,5 mm 0.25"**



**160x320 cm 63"x126"**  
**Rett. Rect.**

Stuoia disponibile, a pagamento, su richiesta.  
Fiber available upon request, with surcharge.



PREMIUM SINTERED  
STONE MANUFACTURER

[www.nuovocorso.sg](http://www.nuovocorso.sg)

---

**NUOVOCORSO  
SINTERED STONE**

## **PIETRA GRIGIA LIGHT**

---

Suitable for Kitchen Countertops,  
Backsplashes, Dining Tables,  
Vanities, Feature Walls,  
Bathrooms, Floors and the  
Ventilated Facades.

  
**BIGSLABS**®  
BY  
nuovocorso  
Made in Italy

PREMIUM SINTERED  
STONE MANUFACTURER



# PIETRA GRIGIA LIGHT

SINTERED STONE

## FORMATO / SIZE



**162x324 cm** 64"x127"  
full size (12 mm)

**160x320 cm** 63"x126"  
Rett. Rect. (6,5 mm)

## SPESSORI / THICKNESSES



**6,5 mm** 0.25"  
**12 mm** 0.47"

## FINITURE / FINISHES



**Naturale** Matt  
**Levigato** Polished

Stuoia disponibile, a pagamento, su richiesta.  
Fiber available upon request, with surcharge.

  
**BIGSLABS**<sup>®</sup>  
BY  
**.nuovocorso**  
Made in Italy

PREMIUM SINTERED  
STONE MANUFACTURER

[www.nuovocorso.sg](http://www.nuovocorso.sg)

---

**NUOVOCORSO  
SINTERED STONE**

---

**PORTORO**

---

Suitable for Kitchen Countertops,  
Backsplashes, Dining Tables,  
Vanities, Feature Walls,  
Bathrooms, Floors and the  
Ventilated Facades.

  
**BIGSLABS**®  
BY  
nuovocorso  
Made in Italy

PREMIUM SINTERED  
STONE MANUFACTURER





# PORTORO

## SINTERED STONE

### FORMATO / SIZE



**162x324 cm** 64"x127"  
full size (12 mm)

**160x320 cm** 63"x126"  
 **Rett. Rect.** (6,5 mm)

### SPESSORI / THICKNESSES



**6,5 mm** 0.25"  
**12 mm** 0.47"

### FINITURE / FINISHES



**Naturale Matt**  
**Levigato Polished**

Stuoia disponibile, a pagamento, su richiesta.  
Fiber available upon request, with surcharge.

  
**BIGSLABS**<sup>®</sup>  
BY  
**.nuovocorso**  
Made in Italy

PREMIUM SINTERED  
STONE MANUFACTURER

[www.nuovocorso.sg](http://www.nuovocorso.sg)

**NUOVOCORSO  
SINTERED STONE**

## **PRECIOUS STONE**

Suitable for Kitchen Countertops,  
Backsplashes, Dining Tables,  
Vanities, Feature Walls,  
Bathrooms, Floors and the  
Ventilated Facades.

  
**BIGSLABS**®  
BY  
nuovocorso  
Made in Italy

PREMIUM SINTERED  
STONE MANUFACTURER



# PRECIOUS STONE

SINTERED STONE

## FORMATO / SIZE



**162x324 cm** 64"x127"  
full size

## SPESSORI / THICKNESSES



**12 mm** 0.47"  
**2 cm** 0.78"

## FINITURE / FINISHES



**Naturale Matt**  
**Levigato Polished**

Stuoia disponibile, a pagamento, su richiesta.  
Fiber available upon request, with surcharge.

  
**BIGSLABS**®  
BY  
**nuovocorso**  
Made in Italy

PREMIUM SINTERED  
STONE MANUFACTURER

[www.nuovocorso.sg](http://www.nuovocorso.sg)

---

**NUOVOCORSO  
SINTERED STONE**

**SAHARA  
GREY**

---

Suitable for Kitchen Countertops,  
Backsplashes, Dining Tables,  
Vanities, Feature Walls,  
Bathrooms, Floors and the  
Ventilated Facades.

  
**BIGSLABS**®  
BY  
nuovocorso  
Made in Italy

PREMIUM SINTERED  
STONE MANUFACTURER





# SAHARA GREY

## SINTERED STONE

### FORMATO / SIZE



**162x324 cm** 64"x127"  
full size (12 mm)

**160x320 cm** 63"x126"  
Rett. Rect. (6,5 mm)

### SPESSORI / THICKNESSES



**6,5 mm** 0.25"  
**12 mm** 0.47"

### FINITURE / FINISHES



**Naturale Matt**  
**Levigato Polished**

Stuoia disponibile, a pagamento, su richiesta.  
Fiber available upon request, with surcharge.

  
**BIGSLABS**<sup>®</sup>  
BY  
**.nuovocorso**  
Made in Italy

PREMIUM SINTERED  
STONE MANUFACTURER

[www.nuovocorso.sg](http://www.nuovocorso.sg)

---

**NUOVOCORSO  
SINTERED STONE**

**SAHARA  
NOIR**

---

Suitable for Kitchen Countertops,  
Backsplashes, Dining Tables,  
Vanities, Feature Walls,  
Bathrooms, Floors and the  
Ventilated Facades.

  
**BIGSLABS**®  
BY  
nuovocorso  
Made in Italy

PREMIUM SINTERED  
STONE MANUFACTURER



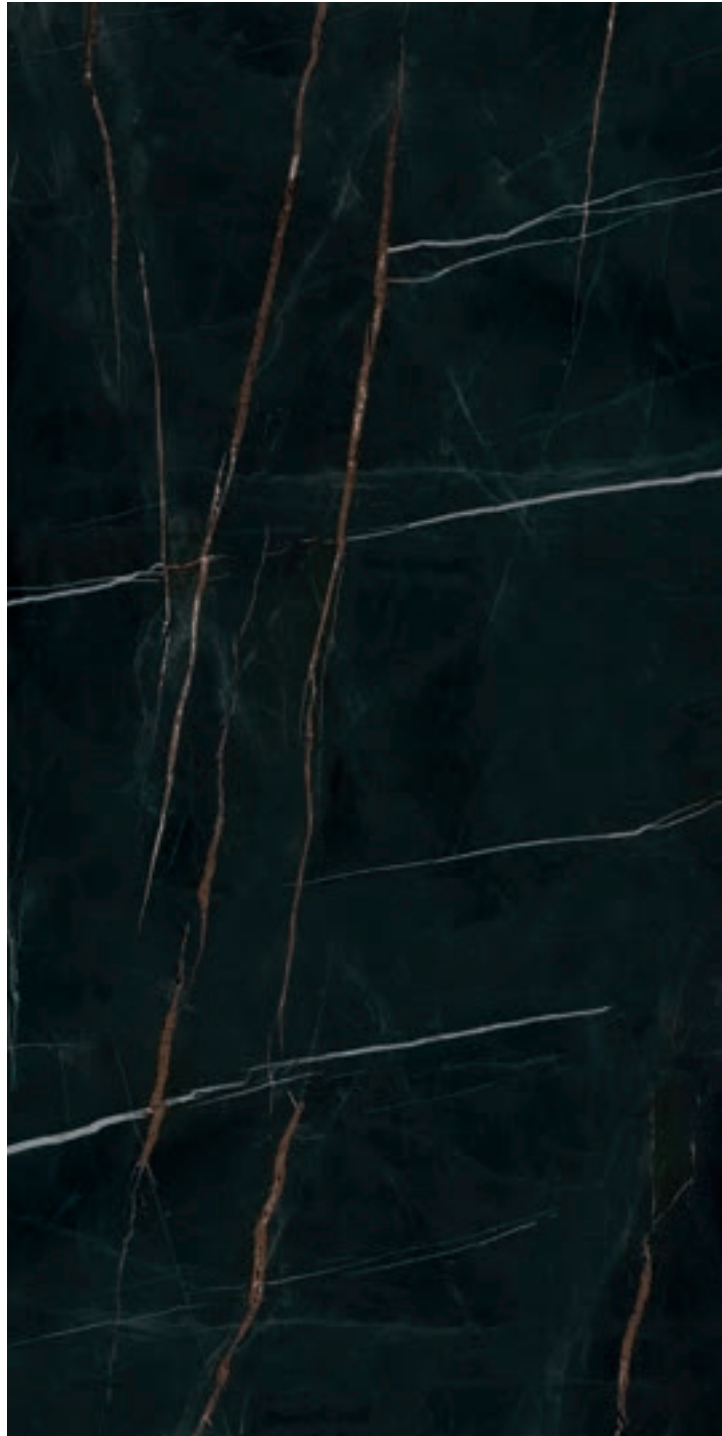
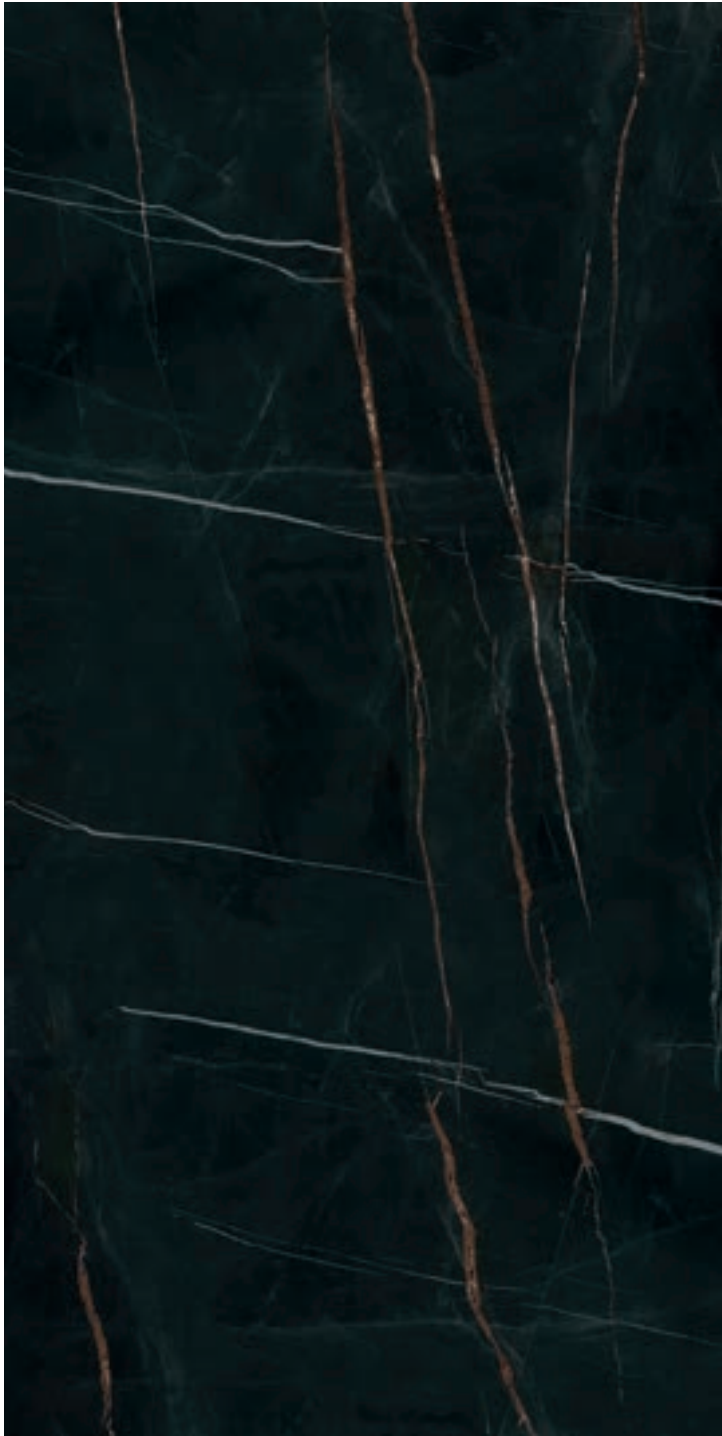

# SAHARA NOIR

SINTERED STONE

## FORMATO / SIZE



**162x324 cm** 64"x127"  
full size (12 mm)

**160x320 cm** 63"x126"  
Rett. Rect. (6,5 mm)

## SPESSORI / THICKNESSES



**6,5 mm** 0.25"  
**12 mm** 0.47"

## FINITURE / FINISHES



**Naturale Matt**  
**Levigato Polished**

Stuoia disponibile, a pagamento, su richiesta.  
Fiber available upon request, with surcharge.

  
**BIGSLABS**<sup>®</sup>  
BY  
**.nuovocorso**  
Made in Italy

PREMIUM SINTERED  
STONE MANUFACTURER

[www.nuovocorso.sg](http://www.nuovocorso.sg)

---

## **NUOVOCORSO SINTERED STONE**

---

### **SHAPE**

---

Suitable for Kitchen Countertops,  
Backsplashes, Dining Tables,  
Vanities, Feature Walls,  
Bathrooms, Floors and the  
Ventilated Facades.

  
**BIGSLABS**®  
BY  
**nuovocorso**  
Made in Italy

PREMIUM SINTERED  
STONE MANUFACTURER





# SHAPE

## SINTERED STONE

### FORMATO / SIZE



**162x324 cm** 64"x127"  
full size (12 mm)

**160x320 cm** 63"x126"  
Rett. Rect. (6,5 mm)

### SPESSORI / THICKNESSES



**6,5 mm** 0.25"  
**12 mm** 0.47"

### FINITURE / FINISHES



**Naturale Matt**  
**Levigato Polished**

Stuoia disponibile, a pagamento, su richiesta.  
Fiber available upon request, with surcharge.

  
**BIGSLABS**<sup>®</sup>  
BY  
**.nuovocorso**  
Made in Italy

PREMIUM SINTERED  
STONE MANUFACTURER

[www.nuovocorso.sg](http://www.nuovocorso.sg)

**NUOVOCORSO  
SINTERED STONE**

## **STATUARIETTO LIGHT**

Suitable for Kitchen Countertops,  
Backsplashes, Dining Tables,  
Vanities, Feature Walls,  
Bathrooms, Floors and the  
Ventilated Facades.

  
**BIGSLABS**®  
BY  
**nuovocorso**  
Made in Italy

PREMIUM SINTERED  
STONE MANUFACTURER





# STATUARIETTO LIGHT

SINTERED STONE

## FORMATO / SIZE



**162x324 cm** 64"x127"  
full size (12 mm)

**160x320 cm** 63"x126"  
Rett. Rect. (6,5 mm)

## SPESSORI / THICKNESSES



**6,5 mm** 0.25"  
**12 mm** 0.47"

## FINITURE / FINISHES



**Naturale Matt**  
**Levigato Polished**

Stuoia disponibile, a pagamento, su richiesta.  
Fiber available upon request, with surcharge.

  
**BIGSLABS**®  
BY  
**.nuovocorso**  
Made in Italy

PREMIUM SINTERED  
STONE MANUFACTURER

[www.nuovocorso.sg](http://www.nuovocorso.sg)

**NUOVOCORSO  
SINTERED STONE**

## **STATUARIO**

**12mm**

Suitable for Kitchen Countertops,  
Backsplashes, Dining Tables,  
Vanities, Feature Walls,  
Bathrooms, Floors and the  
Ventilated Facades.

  
**BIGSLABS**®  
BY  
**nuovocorso**  
Made in Italy

PREMIUM SINTERED  
STONE MANUFACTURER



# STATUARIO

SINTERED STONE

FORMATO / SIZE



**162x324 cm** 64"x127"  
full size

SPESSORI / THICKNESSES



**12 mm** 0.47"

FINITURE / FINISHES



**Naturale Matt**  
**Levigato Polished**

Stuoia disponibile, a pagamento, su richiesta.  
Fiber available upon request, with surcharge.

  
**BIGSLABS**<sup>®</sup>  
BY  
**nuovocorso**  
Made in Italy

PREMIUM SINTERED  
STONE MANUFACTURER

[www.nuovocorso.sg](http://www.nuovocorso.sg)

**NUOVOCORSO  
SINTERED STONE**

## **STATUARIO**

**6,5mm**

Suitable for Kitchen Countertops,  
Backsplashes, Dining Tables,  
Vanities, Feature Walls,  
Bathrooms, Floors and the  
Ventilated Facades.

  
**BIGSLABS**®  
BY  
**nuovocorso**  
Made in Italy

PREMIUM SINTERED  
STONE MANUFACTURER



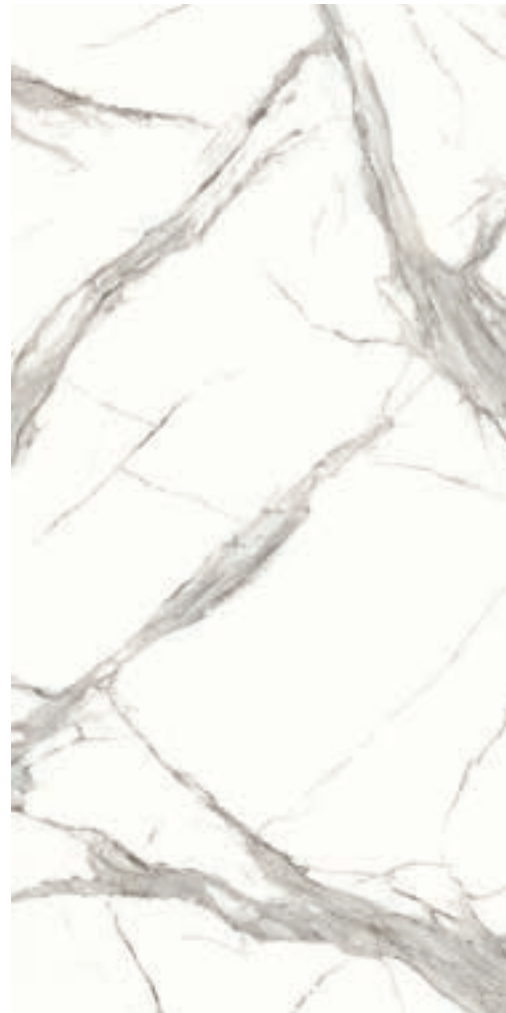
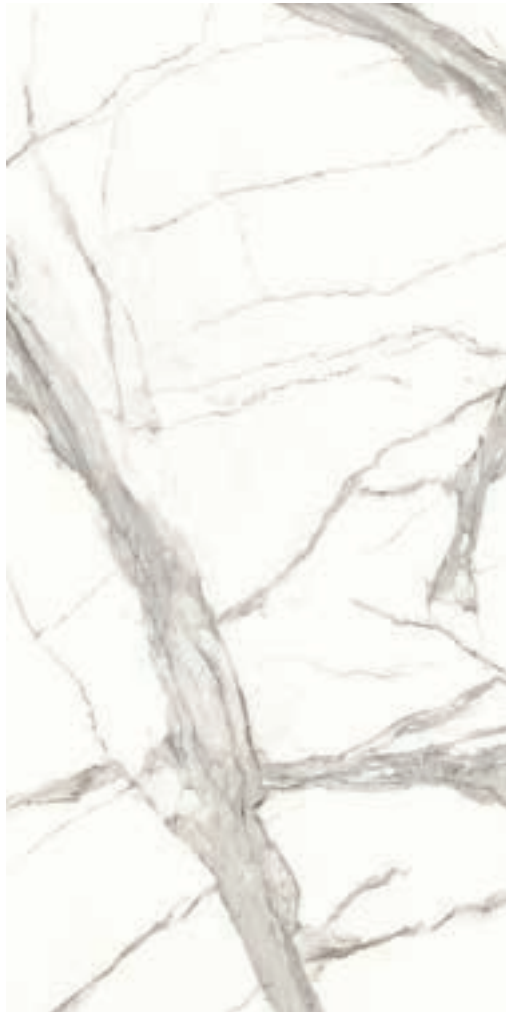
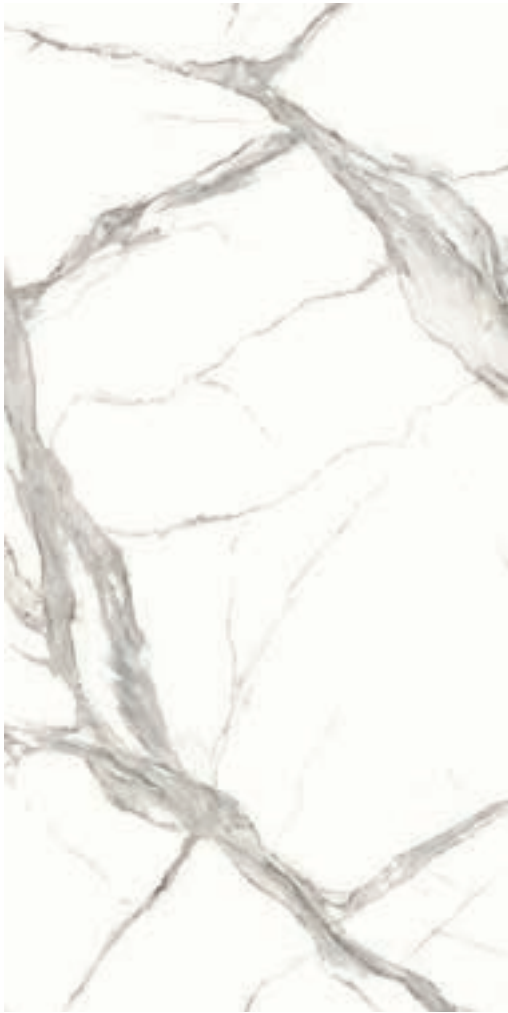

# STATUARIO

## SINTERED STONE

FINITURE / FINISHES

SPESSORI / THICKNESSES

FORMATO / SIZE



**Naturale** Matt  
**Levigato** Polished



**6,5 mm** 0.25"



**160x320 cm** 63"x126"  
 **Rett. Rect.**

Stuoia disponibile, a pagamento, su richiesta.  
Fiber available upon request, with surcharge.



PREMIUM SINTERED  
STONE MANUFACTURER

[www.nuovocorso.sg](http://www.nuovocorso.sg)

**NUOVOCORSO  
SINTERED STONE**

## **STATUARIO IMPERIALE LIGHT**

Suitable for Kitchen Countertops,  
Backsplashes, Dining Tables,  
Vanities, Feature Walls,  
Bathrooms, Floors and the  
Ventilated Facades.

  
**BIGSLABS**®  
BY  
nuovocorso  
Made in Italy

PREMIUM SINTERED  
STONE MANUFACTURER





# STATUARIO IMPERIALE LIGHT

---

## SINTERED STONE

### FORMATO / SIZE



**162x324 cm** 64"x127"  
full size (12 mm)

**160x320 cm** 63"x126"  
Rett. Rect. (6,5 mm)

### SPESSORI / THICKNESSES



**6,5 mm** 0.25"  
**12 mm** 0.47"

### FINITURE / FINISHES



**Naturale** Matt  
**Levigato** Polished  
**Honed** Honed

Stuoia disponibile, a pagamento, su richiesta.  
Fiber available upon request, with surcharge.

  
**BIGSLABS**<sup>®</sup>  
BY  
**nuovocorso**  
Made in Italy

PREMIUM SINTERED  
STONE MANUFACTURER

[www.nuovocorso.sg](http://www.nuovocorso.sg)

**NUOVOCORSO  
SINTERED STONE**

## **STATUARIO LEONARDO**

Suitable for Kitchen Countertops,  
Backsplashes, Dining Tables,  
Vanities, Feature Walls,  
Bathrooms, Floors and the  
Ventilated Facades.

  
**BIGSLABS**®  
BY  
nuovocorso  
Made in Italy

PREMIUM SINTERED  
STONE MANUFACTURER



# STATUARIO LEONARDO

SINTERED STONE

## FORMATO / SIZE



**162x324 cm** 64"x127"  
full size (12 mm / 2 cm)

**160x320 cm** 63"x126"  
Rett. Rect. (6,5 mm)

## SPESSORI / THICKNESSES



**6,5 mm** 0.25"  
**12 mm** 0.47"  
**2 cm** 0.78"

## FINITURE / FINISHES



**Naturale** Matt  
**Levigato** Polished  
**Honed** Honed

Stuoia disponibile, a pagamento, su richiesta.  
Fiber available upon request, with surcharge.

  
**BIGSLABS**<sup>®</sup>  
BY  
**.nuovocorso**  
Made in Italy

PREMIUM SINTERED  
STONE MANUFACTURER

[www.nuovocorso.sg](http://www.nuovocorso.sg)

**NUOVOCORSO  
SINTERED STONE**

## **STATUARIO RAFFAELLO**

Suitable for Kitchen Countertops,  
Backsplashes, Dining Tables,  
Vanities, Feature Walls,  
Bathrooms, Floors and the  
Ventilated Facades.

  
**BIGSLABS**®  
BY  
**nuovocorso**  
Made in Italy

PREMIUM SINTERED  
STONE MANUFACTURER



# STATUARIO RAFFAELLO

SINTERED STONE

## FORMATO / SIZE



**162x324 cm** 64"x127"  
full size

## SPESSORI / THICKNESSES



**12 mm** 0.47"  
**2 cm** 0.78"

## FINITURE / FINISHES



**Naturale Matt**  
**Levigato Polished**

Stuoia disponibile, a pagamento, su richiesta.  
Fiber available upon request, with surcharge.

  
**BIGSLABS**®  
BY  
**nuovocorso**  
Made in Italy

PREMIUM SINTERED  
STONE MANUFACTURER

[www.nuovocorso.sg](http://www.nuovocorso.sg)

---

**NUOVOCORSO  
SINTERED STONE**

---

**SUPERWHITE**

---

Suitable for Kitchen Countertops,  
Backsplashes, Dining Tables,  
Vanities, Feature Walls,  
Bathrooms, Floors and the  
Ventilated Facades.

  
**BIGSLABS**®  
BY  
nuovocorso  
Made in Italy

PREMIUM SINTERED  
STONE MANUFACTURER

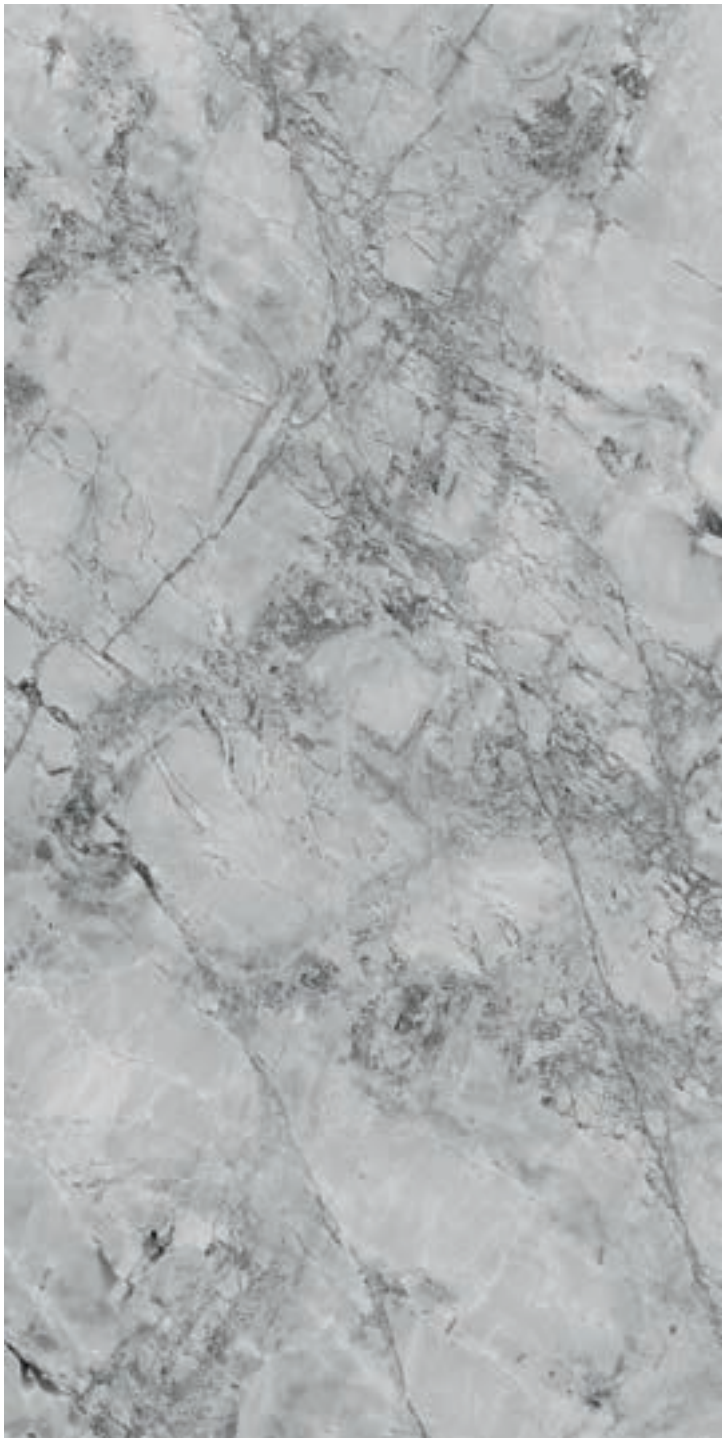

# SUPERWHITE

## SINTERED STONE

### FORMATO / SIZE



**162x324 cm** 64"x127"  
full size (12 mm)

**160x320 cm** 63"x126"  
Rett. Rect. (6,5 mm)

### SPESSORI / THICKNESSES



**6,5 mm** 0.25"  
**12 mm** 0.47"

### FINITURE / FINISHES



**Naturale Matt**  
**Levigato Polished**

Stuoia disponibile, a pagamento, su richiesta.  
Fiber available upon request, with surcharge.

  
**BIGSLABS**®  
BY  
**.nuovocorso**  
Made in Italy

PREMIUM SINTERED  
STONE MANUFACTURER

[www.nuovocorso.sg](http://www.nuovocorso.sg)

---

**NUOVOCORSO  
SINTERED STONE**

---

**TAJ MAHAL**

---

**12mm / 2cm**

Suitable for Kitchen Countertops,  
Backsplashes, Dining Tables,  
Vanities, Feature Walls,  
Bathrooms, Floors and the  
Ventilated Facades.

  
**BIGSLABS**®  
BY  
**nuovocorso**  
Made in Italy

PREMIUM SINTERED  
STONE MANUFACTURER





# TAJ MAHAL

## SINTERED STONE

### FORMATO / SIZE



**162x324 cm** 64"x127"  
full size

### SPESSORI / THICKNESSES



**12 mm** 0.47"  
**2 cm** 0.78"

### FINITURE / FINISHES



**Naturale Matt**  
**Levigato Polished**

Stuoia disponibile, a pagamento, su richiesta.  
Fiber available upon request, with surcharge.

  
**BIGSLABS**®  
BY  
**nuovocorso**  
Made in Italy

PREMIUM SINTERED  
STONE MANUFACTURER

[www.nuovocorso.sg](http://www.nuovocorso.sg)

**NUOVOCORSO  
SINTERED STONE**

**TAJ MAHAL**

**6,5mm**

Suitable for Kitchen Countertops,  
Backsplashes, Dining Tables,  
Vanities, Feature Walls,  
Bathrooms, Floors and the  
Ventilated Facades.

  
**BIGSLABS**®  
BY  
**nuovocorso**  
Made in Italy

PREMIUM SINTERED  
STONE MANUFACTURER





# TAJ MAHAL

## SINTERED STONE

FINITURE / FINISHES

SPESSORI / THICKNESSES

FORMATO / SIZE



**Naturale** Matt  
**Levigato** Polished



**6,5 mm** 0.25"



**160x320 cm** 63"x126"  
**Rett. Rect.**

Stuoia disponibile, a pagamento, su richiesta.  
Fiber available upon request, with surcharge.



PREMIUM SINTERED  
STONE MANUFACTURER

[www.nuovocorso.sg](http://www.nuovocorso.sg)

**NUOVOCORSO  
SINTERED STONE**

## **TINTA UNITA BIANCO**

Suitable for Kitchen Countertops,  
Backsplashes, Dining Tables,  
Vanities, Feature Walls,  
Bathrooms, Floors and the  
Ventilated Facades.

  
**BIGSLABS**®  
BY  
nuovocorso  
Made in Italy

PREMIUM SINTERED  
STONE MANUFACTURER

# TINTA UNITA BIANCO

SINTERED STONE

## FORMATO / SIZE



**162x324 cm** 64"x127"  
full size (12 mm / 2 cm)

**160x320 cm** 63"x126"  
**Rett. Rect.** (6,5 mm)

## SPESSORI / THICKNESSES



**6,5 mm** 0.25"

**12 mm** 0.47"

**2 cm** 0.78"

## FINITURE / FINISHES



**Naturale Matt**  
**Levigato Polished**

Stuoia disponibile, a pagamento, su richiesta.  
Fiber available upon request, with surcharge.

  
**BIGSLABS**®  
BY  
**nuovocorso**  
Made in Italy

PREMIUM SINTERED  
STONE MANUFACTURER

[www.nuovocorso.sg](http://www.nuovocorso.sg)

**NUOVOCORSO  
SINTERED STONE**

## **TINTA UNITA NERO**

Suitable for Kitchen Countertops,  
Backsplashes, Dining Tables,  
Vanities, Feature Walls,  
Bathrooms, Floors and the  
Ventilated Facades.

  
**BIGSLABS**®  
BY  
nuovocorso  
Made in Italy

PREMIUM SINTERED  
STONE MANUFACTURER

# TINTA UNITA NERO

SINTERED STONE

## FORMATO / SIZE



**162x324 cm** 64"x127"  
full size (12 mm)

**160x320 cm** 63"x126"  
**Rett. Rect.** (6,5 mm)

## SPESSORI / THICKNESSES



**6,5 mm** 0.25"  
**12 mm** 0.47"

## FINITURE / FINISHES



**Naturale Matt**

Stuoia disponibile, a pagamento, su richiesta.  
Fiber available upon request, with surcharge.

  
**BIGSLABS**®  
BY  
**nuovocorso**  
Made in Italy

PREMIUM SINTERED  
STONE MANUFACTURER

[www.nuovocorso.sg](http://www.nuovocorso.sg)

**NUOVOCORSO  
SINTERED STONE**

## **TRAVERTINO WHITE**

Suitable for Kitchen Countertops,  
Backsplashes, Dining Tables,  
Vanities, Feature Walls,  
Bathrooms, Floors and the  
Ventilated Facades.

  
**BIGSLABS**®  
BY  
nuovocorso  
Made in Italy

PREMIUM SINTERED  
STONE MANUFACTURER





# TRAVERTINO WHITE

SINTERED STONE

## FORMATO / SIZE



**162x324 cm** 64"x127"  
full size (12 mm / 2 cm)

**160x320 cm** 63"x126"  
Rett. Rect. (6,5 mm)

## SPESSORI / THICKNESSES



**6,5 mm** 0.25"  
**12 mm** 0.47"  
**2 cm** 0.78"

## FINITURE / FINISHES



**Naturale** Matt  
**Levigato** Polished

Stuoia disponibile, a pagamento, su richiesta.  
Fiber available upon request, with surcharge.

  
**BIGSLABS**<sup>®</sup>  
BY  
**.nuovocorso**  
Made in Italy

PREMIUM SINTERED  
STONE MANUFACTURER

[www.nuovocorso.sg](http://www.nuovocorso.sg)

---

## **NUOVOCORSO SINTERED STONE**

---

### **WAVE**

---

Suitable for Kitchen Countertops,  
Backsplashes, Dining Tables,  
Vanities, Feature Walls,  
Bathrooms, Floors and the  
Ventilated Facades.

  
**BIGSLABS**®  
BY  
nuovocorso  
Made in Italy

PREMIUM SINTERED  
STONE MANUFACTURER





# WAVE

## SINTERED STONE

### FORMATO / SIZE



**162x324 cm** 64"x127"  
full size (12 mm)

**160x320 cm** 63"x126"  
Rett. Rect. (6,5 mm)

### SPESSORI / THICKNESSES



**6,5 mm** 0.25"  
**12 mm** 0.47"

### FINITURE / FINISHES



**Naturale Matt**  
**Levigato Polished**

Stuoia disponibile, a pagamento, su richiesta.  
Fiber available upon request, with surcharge.

  
**BIGSLABS**<sup>®</sup>  
BY  
**.nuovocorso**  
Made in Italy

PREMIUM SINTERED  
STONE MANUFACTURER

[www.nuovocorso.sg](http://www.nuovocorso.sg)

**NUOVOCORSO  
SINTERED STONE**

## **WOOD ESSENCE ALMOND**

Suitable for Kitchen Countertops,  
Backsplashes, Dining Tables,  
Vanities, Feature Walls,  
Bathrooms, Floors and the  
Ventilated Facades.

  
**BIGSLABS**®  
BY  
nuovocorso  
Made in Italy

PREMIUM SINTERED  
STONE MANUFACTURER



# WOOD ESSENCE ALMOND

SINTERED STONE

## FORMATO / SIZE



**162x324 cm** 64"x127"  
full size (12 mm)

**160x320 cm** 63"x126"  
Rett. Rect. (6,5 mm)

## SPESSORI / THICKNESSES



**6,5 mm** 0.25"  
**12 mm** 0.47"

## FINITURE / FINISHES



**Naturale Matt**  
**Stripes Matt**

Stuoia disponibile, a pagamento, su richiesta.  
Fiber available upon request, with surcharge.

  
**BIGSLABS**<sup>®</sup>  
BY  
**nuovocorso**  
Made in Italy

PREMIUM SINTERED  
STONE MANUFACTURER



[www.nuovocorso.sg](http://www.nuovocorso.sg)

**NUOVOCORSO  
SINTERED STONE**

## **WOOD ESSENCE NUT**

Suitable for Kitchen Countertops,  
Backsplashes, Dining Tables,  
Vanities, Feature Walls,  
Bathrooms, Floors and the  
Ventilated Facades.

  
**BIGSLABS**®  
BY  
nuovocorso  
Made in Italy

PREMIUM SINTERED  
STONE MANUFACTURER



# WOOD ESSENCE NUT

SINTERED STONE

## FORMATO / SIZE



**162x324 cm** 64"x127"  
full size (12 mm)

**160x320 cm** 63"x126"  
Rett. Rect. (6,5 mm)

## SPESSORI / THICKNESSES



**6,5 mm** 0.25"  
**12 mm** 0.47"

## FINITURE / FINISHES



**Naturale Matt**  
**Stripes Matt**

Stuoia disponibile, a pagamento, su richiesta.  
Fiber available upon request, with surcharge.

  
**BIGSLABS**<sup>®</sup>  
BY  
**nuovocorso**  
Made in Italy

PREMIUM SINTERED  
STONE MANUFACTURER

[www.nuovocorso.sg](http://www.nuovocorso.sg)

**NUOVOCORSO  
SINTERED STONE**

## **WOOD ESSENCE OAK**

Suitable for Kitchen Countertops,  
Backsplashes, Dining Tables,  
Vanities, Feature Walls,  
Bathrooms, Floors and the  
Ventilated Facades.

  
**BIGSLABS**®  
BY  
nuovocorso  
Made in Italy

PREMIUM SINTERED  
STONE MANUFACTURER





# WOOD ESSENCE OAK

SINTERED STONE

## FORMATO / SIZE



**162x324 cm** 64"x127"  
full size (12 mm)

**160x320 cm** 63"x126"  
Rett. Rect. (6,5 mm)

## SPESSORI / THICKNESSES



**6,5 mm** 0.25"  
**12 mm** 0.47"

## FINITURE / FINISHES



**Naturale Matt**  
**Stripes Matt**

Stuoia disponibile, a pagamento, su richiesta.  
Fiber available upon request, with surcharge.

  
**BIGSLABS**<sup>®</sup>  
BY  
**nuovocorso**  
Made in Italy

PREMIUM SINTERED  
STONE MANUFACTURER

# STRUCTURED STONES



  
**BIGSLABS**  
BY  
nuovocorso

[www.nuovocorso.sg](http://www.nuovocorso.sg)

**NUOVOCORSO  
SINTERED STONE**

## **ABSOLUT BLACK STRUCTURED**

Suitable for Kitchen Countertops,  
Backsplashes, Dining Tables,  
Vanities, Feature Walls,  
Bathrooms, Floors and the  
Ventilated Facades.

  
**BIGSLABS**®  
BY  
nuovocorso  
Made in Italy

PREMIUM SINTERED  
STONE MANUFACTURER

# ABSOLUT BLACK STRUCTURED

SINTERED STONE

Dettaglio Detail

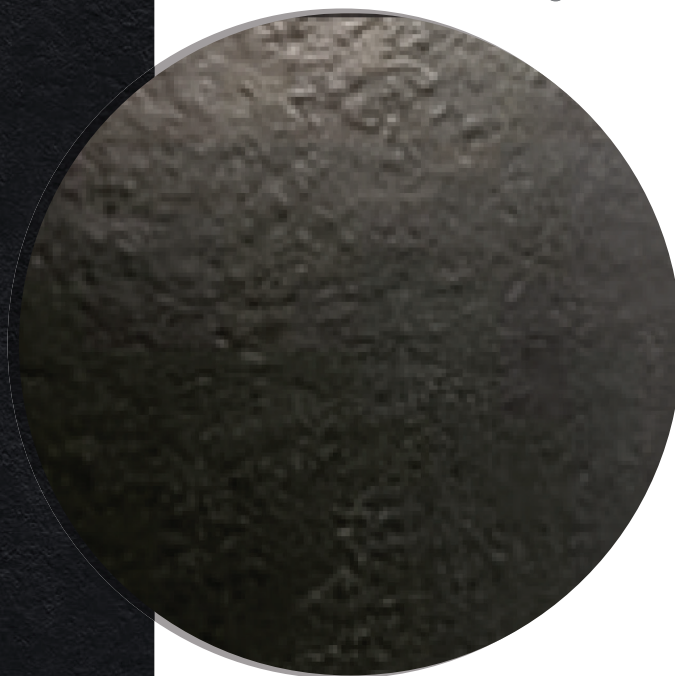

## FORMATO / SIZE



**162x324 cm** 64"x127"  
full size (12 mm/2cm)

**160x320 cm** 63"x126"  
**Rett. Rect.** (6,5 mm)

## SPESSORI / THICKNESSES



**6.5 mm** 0.25"

**12 mm** 0.47"

**2cm** 0.78"

## FINITURE / FINISHES



**Structured**

Stuoia disponibile, a pagamento, su richiesta.  
Fiber available upon request, with surcharge.

  
**BIGSLABS**®  
BY  
**nuovocorso**  
Made in Italy

PREMIUM SINTERED  
STONE MANUFACTURER

[www.nuovocorso.sg](http://www.nuovocorso.sg)

**NUOVOCORSO  
SINTERED STONE**

## **ABSOLUT WHITE STRUCTURED**

Suitable for Kitchen Countertops,  
Backsplashes, Dining Tables,  
Vanities, Feature Walls,  
Bathrooms, Floors and the  
Ventilated Facades.

  
**BIGSLABS**®  
BY  
nuovocorso  
Made in Italy

PREMIUM SINTERED  
STONE MANUFACTURER





Dettaglio Detail



# ABSOLUT WHITE STRUCTURED

SINTERED STONE

## FORMATO / SIZE



**162x324 cm** 64"x127"  
full size (12 mm/2cm)

**160x320 cm** 63"x126"  
**Rett. Rect.** (6,5 mm)

## SPESSORI / THICKNESSES



**6.5 mm** 0.25"  
**12 mm** 0.47"  
**2cm** 0.78"

## FINITURE / FINISHES



**Structured**

Stuoia disponibile, a pagamento, su richiesta.  
Fiber available upon request, with surcharge.

  
**BIGSLABS**<sup>®</sup>  
BY  
**nuovocorso**  
Made in Italy

PREMIUM SINTERED  
STONE MANUFACTURER

[www.nuovocorso.sg](http://www.nuovocorso.sg)

**NUOVOCORSO  
SINTERED STONE**

## **ARENARIA STONE BEIGE**

Suitable for Kitchen Countertops,  
Backsplashes, Dining Tables,  
Vanities, Feature Walls,  
Bathrooms, Floors and the  
Ventilated Facades.

  
**BIGSLABS**®  
BY  
nuovocorso  
Made in Italy

PREMIUM SINTERED  
STONE MANUFACTURER





Dettaglio Detail



# ARENARIA STONE BEIGE

SINTERED STONE

**FORMATO / SIZE**



**162x324 cm 64"x127"**  
full size (12 mm / 2 cm)

**SPESSORI / THICKNESSES**



**12 mm 0.47"**  
**2 cm 0.78"**

**FINITURE / FINISHES**



**Structured  
Leather  
Soft Structured**

Stuoia disponibile, a pagamento, su richiesta.  
Fiber available upon request, with surcharge.



PREMIUM SINTERED  
STONE MANUFACTURER

[www.nuovocorso.sg](http://www.nuovocorso.sg)

**NUOVOCORSO  
SINTERED STONE**

## **ARENARIA STONE IVORY**

Suitable for Kitchen Countertops,  
Backsplashes, Dining Tables,  
Vanities, Feature Walls,  
Bathrooms, Floors and the  
Ventilated Facades.

  
**BIGSLABS**®  
BY  
nuovocorso  
Made in Italy

PREMIUM SINTERED  
STONE MANUFACTURER





Dettaglio Detail



# ARENARIA STONE IVORY

SINTERED STONE

## FORMATO / SIZE



**162x324 cm** 64"x127"  
full size (12 mm / 2 cm)

## SPESSORI / THICKNESSES



**12 mm** 0.47"  
**2 cm** 0.78"

## FINITURE / FINISHES



**Structured  
Leather  
Soft Structured**

Stuoia disponibile, a pagamento, su richiesta.  
Fiber available upon request, with surcharge.

  
**BIGSLABS**<sup>®</sup>  
BY  
**.nuovocorso**  
Made in Italy

PREMIUM SINTERED  
STONE MANUFACTURER

[www.nuovocorso.sg](http://www.nuovocorso.sg)

---

**NUOVOCORSO  
SINTERED STONE**

---

**JURA BEIGE**

---

Suitable for Kitchen Countertops,  
Backsplashes, Dining Tables,  
Vainities, Feature Walls,  
Bathrooms, Floors and the  
Ventilated Facades.

  
**BIGSLABS**®  
BY  
nuovocorso  
Made in Italy

PREMIUM SINTERED  
STONE MANUFACTURER





Dettaglio Detail



# JURA BEIGE

SINTERED STONE

## FORMATO / SIZE



**162x324 cm** 64"x127"  
full size (12 mm / 2 cm)

## SPESSORI / THICKNESSES



**12 mm** 0.47"  
**2 cm** 0.78"

## FINITURE / FINISHES



**Structured  
Leather  
Soft Structured**

Stuoia disponibile, a pagamento, su richiesta.  
Fiber available upon request, with surcharge.

  
**BIGSLABS**<sup>®</sup>  
BY  
**nuovocorso**  
Made in Italy

PREMIUM SINTERED  
STONE MANUFACTURER

[www.nuovocorso.sg](http://www.nuovocorso.sg)

**NUOVOCORSO  
SINTERED STONE**

## **LECCESE STONE BEIGE**

Suitable for Kitchen Countertops,  
Backsplashes, Dining Tables,  
Vanities, Feature Walls,  
Bathrooms, Floors and the  
Ventilated Facades.

  
**BIGSLABS**®  
BY  
nuovocorso  
Made in Italy

PREMIUM SINTERED  
STONE MANUFACTURER



Dettaglio Detail



# LECCESE STONE BEIGE

SINTERED STONE

**FORMATO / SIZE**



**162x324 cm 64"x127"**  
full size (12 mm / 2 cm)

**SPESSORI / THICKNESSES**



**12 mm 0.47"**  
**2 cm 0.78"**

**FINITURE / FINISHES**



**Structured  
Leather  
Soft Structured**

Stuoia disponibile, a pagamento, su richiesta.  
Fiber available upon request, with surcharge.



PREMIUM SINTERED  
STONE MANUFACTURER

[www.nuovocorso.sg](http://www.nuovocorso.sg)

**NUOVOCORSO  
SINTERED STONE**

## **LECCESE STONE IVORY**

Suitable for Kitchen Countertops,  
Backsplashes, Dining Tables,  
Vanities, Feature Walls,  
Bathrooms, Floors and the  
Ventilated Facades.

  
**BIGSLABS**®  
BY  
nuovocorso  
Made in Italy

PREMIUM SINTERED  
STONE MANUFACTURER





Dettaglio Detail



# LECCESE STONE IVORY

SINTERED STONE

**FORMATO / SIZE**



**162x324 cm 64"x127"**  
full size (12 mm / 2 cm)

**SPESSORI / THICKNESSES**



**12 mm 0.47"**  
**2 cm 0.78"**

**FINITURE / FINISHES**



**Structured  
Leather  
Soft Structured**

Stuoia disponibile, a pagamento, su richiesta.  
Fiber available upon request, with surcharge.



PREMIUM SINTERED  
STONE MANUFACTURER

[www.nuovocorso.sg](http://www.nuovocorso.sg)

**NUOVOCORSO  
SINTERED STONE**

## **LIMESTONE BEIGE**

Suitable for Kitchen Countertops,  
Backsplashes, Dining Tables,  
Vanities, Feature Walls,  
Bathrooms, Floors and the  
Ventilated Facades.

  
**BIGSLABS**®  
BY  
nuovocorso  
Made in Italy

PREMIUM SINTERED  
STONE MANUFACTURER





Dettaglio Detail

# LIMESTONE BEIGE

## SINTERED STONE

### FORMATO / SIZE



**162x324 cm** 64"x127"  
full size (12 mm / 2 cm)

**160x320 cm** 63"x126"  
**Rett.** Rect. (6,5 mm)

### SPESSORI / THICKNESSES



**12 mm** 0.47"  
**2 cm** 0.78"

### FINITURE / FINISHES



**Structured  
Leather  
Soft Structured**

Stuoia disponibile, a pagamento, su richiesta.  
Fiber available upon request, with surcharge.



PREMIUM SINTERED  
STONE MANUFACTURER

[www.nuovocorso.sg](http://www.nuovocorso.sg)

**NUOVOCORSO  
SINTERED STONE**

## **LIMESTONE IVORY**

Suitable for Kitchen Countertops,  
Backsplashes, Dining Tables,  
Vanities, Feature Walls,  
Bathrooms, Floors and the  
Ventilated Facades.



  
**BIGSLABS**®  
BY  
nuovocorso  
Made in Italy

PREMIUM SINTERED  
STONE MANUFACTURER



Dettaglio Detail



# LIMESTONE IVORY

SINTERED STONE

**FORMATO / SIZE**



**162x324 cm** 64"x127"  
full size (12 mm / 2 cm)

**160x320 cm** 63"x126"  
**Rett.** Rect. (6,5 mm)

**SPESSORI / THICKNESSES**



**12 mm** 0.47"  
**2 cm** 0.78"

**FINITURE / FINISHES**



**Structured  
Leather  
Soft Structured**

Stuoia disponibile, a pagamento, su richiesta.  
Fiber available upon request, with surcharge.



PREMIUM SINTERED  
STONE MANUFACTURER

[www.nuovocorso.sg](http://www.nuovocorso.sg)

**NUOVOCORSO  
SINTERED STONE**

## **NORWEGIAN STONE BEIGE**

Suitable for Kitchen Countertops,  
Backsplashes, Dining Tables,  
Vanities, Feature Walls,  
Bathrooms, Floors and the  
Ventilated Facades.

  
**BIGSLABS**®  
BY  
nuovocorso  
Made in Italy

PREMIUM SINTERED  
STONE MANUFACTURER





Dettaglio Detail



# NORWEGIAN STONE BEIGE

SINTERED STONE

## FORMATO / SIZE



**162x324 cm** 64"x127"  
full size (12 mm / 2 cm)

## SPESSORI / THICKNESSES



**12 mm** 0.47"  
**2 cm** 0.78"

## FINITURE / FINISHES



**Structured  
Leather  
Soft Structured**

Stuoia disponibile, a pagamento, su richiesta.  
Fiber available upon request, with surcharge.

  
**BIGSLABS**®  
BY  
**.nuovocorso**  
Made in Italy

PREMIUM SINTERED  
STONE MANUFACTURER

[www.nuovocorso.sg](http://www.nuovocorso.sg)

**NUOVOCORSO  
SINTERED STONE**

## **NORWEGIAN STONE GREY**

Suitable for Kitchen Countertops,  
Backsplashes, Dining Tables,  
Vanities, Feature Walls,  
Bathrooms, Floors and the  
Ventilated Facades.

  
**BIGSLABS**®  
BY  
nuovocorso  
Made in Italy

PREMIUM SINTERED  
STONE MANUFACTURER





Dettaglio Detail



# NORWEGIAN STONE GREY

SINTERED STONE

**FORMATO / SIZE**



**162x324 cm 64"x127"**  
full size (12 mm / 2 cm)

**SPESSORI / THICKNESSES**



**12 mm 0.47"**  
**2 cm 0.78"**

**FINITURE / FINISHES**



**Structured  
Leather  
Soft Structured**

Stuoia disponibile, a pagamento, su richiesta.  
Fiber available upon request, with surcharge.



PREMIUM SINTERED  
STONE MANUFACTURER

[www.nuovocorso.sg](http://www.nuovocorso.sg)

**NUOVOCORSO  
SINTERED STONE**

**PIERRE  
PARISIENNE  
GREIGE**

Suitable for Kitchen Countertops,  
Backsplashes, Dining Tables,  
Vanities, Feature Walls,  
Bathrooms, Floors and the  
Ventilated Facades.

  
**BIGSLABS**®  
BY  
nuovocorso  
Made in Italy

PREMIUM SINTERED  
STONE MANUFACTURER





Dettaglio Detail



# PIERRE PARISIENNE GREIGE

SINTERED STONE

## FORMATO / SIZE



**162x324 cm** 64"x127"  
full size (12 mm / 2 cm)

## SPESSORI / THICKNESSES



**12 mm** 0.47"  
**2 cm** 0.78"

## FINITURE / FINISHES



**Structured  
Leather  
Soft Structured**

Stuoia disponibile, a pagamento, su richiesta.  
Fiber available upon request, with surcharge.

  
**BIGSLABS**®  
BY  
**.nuovocorso**  
Made in Italy

PREMIUM SINTERED  
STONE MANUFACTURER

[www.nuovocorso.sg](http://www.nuovocorso.sg)

**NUOVOCORSO  
SINTERED STONE**

## **STRUCTURED MARBLE**

Suitable for Kitchen Countertops,  
Backsplashes, Dining Tables,  
Vanities, Feature Walls,  
Bathrooms, Floors and the  
Ventilated Facades.

  
**BIGSLABS**®  
BY  
**nuovocorso**  
Made in Italy

PREMIUM SINTERED  
STONE MANUFACTURER





# STRUCTURED MARBLE

SINTERED STONE

## FORMATO / SIZE



**162x324 cm** 64"x127"  
full size (12 mm / 2 cm)

## SPESSORI / THICKNESSES



**12 mm** 0.47"  
**2 cm** 0.78"

## FINITURE / FINISHES



**Structured**

Stuoia disponibile, a pagamento, su richiesta.  
Fiber available upon request, with surcharge.

  
**BIGSLABS**<sup>®</sup>  
BY  
**nuovocorso**  
Made in Italy

PREMIUM SINTERED  
STONE MANUFACTURER

[www.nuovocorso.sg](http://www.nuovocorso.sg)

**NUOVOCORSO  
SINTERED STONE**

## **TRAVERTINO STONE BEIGE**

Suitable for Kitchen Countertops,  
Backsplashes, Dining Tables,  
Vanities, Feature Walls,  
Bathrooms, Floors and the  
Ventilated Facades.

  
**BIGSLABS**®  
BY  
nuovocorso  
Made in Italy

PREMIUM SINTERED  
STONE MANUFACTURER





# TRAVERTINO STONE BEIGE

SINTERED STONE

## FORMATO / SIZE



**162x324 cm** 64"x127"  
full size (12 mm / 2 cm)

## SPESSORI / THICKNESSES



**12 mm** 0.47"  
**2 cm** 0.78"

## FINITURE / FINISHES



**Structured  
Leather  
Soft Structured**

Stuoia disponibile, a pagamento, su richiesta.  
Fiber available upon request, with surcharge.

  
**BIGSLABS**<sup>®</sup>  
BY  
**.nuovocorso**  
Made in Italy

PREMIUM SINTERED  
STONE MANUFACTURER



[www.nuovocorso.sg](http://www.nuovocorso.sg)

**NUOVOCORSO  
SINTERED STONE**

## **TRAVERTINO STONE WHITE**

Suitable for Kitchen Countertops,  
Backsplashes, Dining Tables,  
Vanities, Feature Walls,  
Bathrooms, Floors and the  
Ventilated Facades.

  
**BIGSLABS**®  
BY  
nuovocorso  
Made in Italy

PREMIUM SINTERED  
STONE MANUFACTURER



# TRAVERTINO STONE WHITE

SINTERED STONE

## FORMATO / SIZE



**162x324 cm** 64"x127"  
full size (12 mm / 2 cm)

## SPESSORI / THICKNESSES



**12 mm** 0.47"  
**2 cm** 0.78"

## FINITURE / FINISHES



**Structured  
Leather  
Soft Structured**

Stuoia disponibile, a pagamento, su richiesta.  
Fiber available upon request, with surcharge.

  
**BIGSLABS**®  
BY  
**.nuovocorso**  
Made in Italy

PREMIUM SINTERED  
STONE MANUFACTURER

# TECHNICAL CHARACTERISTICS

## NUOVOCORSO BIG SLABS SINTERED STONE

FEATURES	UNIT OF MESUREMENT	MEAN VALUE	REQUIRED STANDARDS	ETST METHOD
DIMENSIONS - LENGHT AND WIDTH	%	COMPLIANT	+/- 0,6 MAX	UNI EN ISO 10545-2
SIDES STRAIGHTNESS	%	COMPLIANT	+/- 0,5 MAX	UNI EN ISO 10545-2
SIDES ORTOGONALITY	%	COMPLIANT	+/- 0,6 MAX	UNI EN ISO 10545-2
FLATNESS	%	COMPLIANT	+/- 0,5 MAX	UNI EN ISO 10545-2
THICKNESS	%	COMPLIANT	+/- 5 MAX FROM DECLARED VALUE	UNI EN ISO 10545-2
WATER ABSORPTION	%	COMPLIANT	≤ 0,5	UNI EN ISO 10545-3
BREAKING STRENGTH	N	COMPLIANT	≥ 700 SE SPESS. < 7,5 ≥ 1300 SE SPESS. ≥ 7,5	UNI EN ISO 10545-4
BREAKING MODULUS	N/mm <sup>2</sup>	COMPLIANT	≥ 35	UNI EN ISO 10545-4
COEFFICIENT OF LINEAR THERMAIL - EXPANSION	"MK [- 1]	<b>a7,00</b>	DECLARED VALUE	UNI EN ISO 10545-8
RESISTANCE TO THERMAL SHOCK		<b>RESIST</b>	PASS ACC. TO 10545-1	UNI EN ISO 10545-9
CHEMICAL RESISTANCE		COMPLIANT	MINGB	UNI EN ISO 10545-13
RESISTANCE TO ACID AND LOW CONCENTRATION BASES		<b>ULA</b>	METHOD AVAILABLE	UNI EN ISO 10545-13
FROST RESISTANCE		RESIST	PASS ACC. TO 10545-1	UNI EN ISO 10545-12
STAIN RESISTANCE		COMPLIANT	MINIMUM CLASS 3	UNI EN ISO 10545-14
SURFACE HARDNESS		<b>5-8</b>	≥ 5	[EN 101]



100% Natural  
No harmful substances



Hygienic  
Suitable for food contact



Scratch-Resistant  
Resistant to use and abrasion



Easy to clean - Resistant to  
conventional chemical detergents



Frost resistant  
Weather resistant



Uv resistant



Resistant to high temperatures  
Heat resistant



Waterpro of - Absorption  
coefficient near zero

OFFICE & SHOWROOM  
33 UBI AVENUE 3 #07-17 TOWER B VERTEX SINGAPORE 408868  
Tel.: +65 6659 0782  
Mobile No. : +65 85103842  
Email : info@nuovocorso.sg  
Website : www.nuovocorso.sg

  
Premium Sintered Stone  
Made in Italy



  
**BIGSLABS**  
BY  
**nuovocorso**  
www.nuovocorso.sg

# PACKAGING

Nuovocorso slabs can be packed in crate or on A-Frame

## CRATE

SIZE → 345x175x37 cm 136"x69"x14" PESO  
EMPTY WEIGHT → 120 KG

## WOOD A-FRAME

A-FRAME → 330x75x200 cm 130"x30"x79"  
EMPTY WEIGHT → 240 KG

## METAL A-FRAME

A-FRAME → 330x75x200 cm 130"x30"x79"  
EMPTY WEIGHT → 130 KG

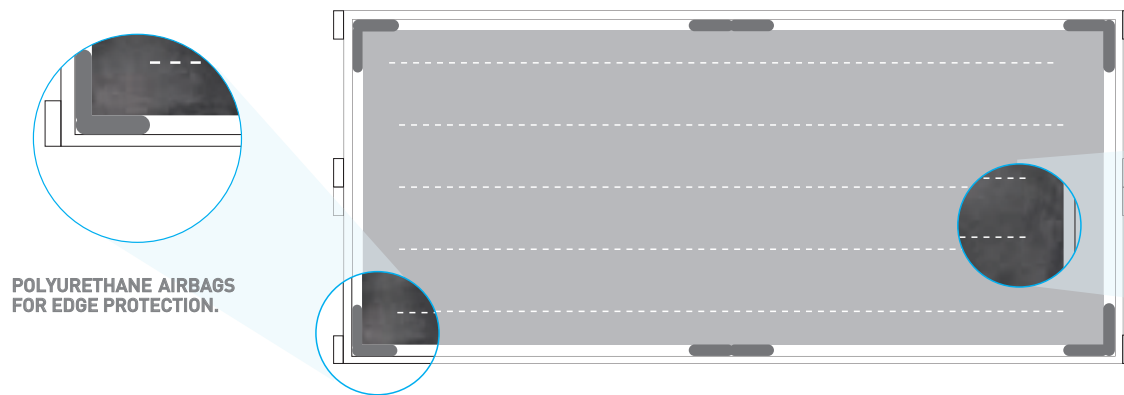

POLYURETHANE AIRBAGS FOR EDGE PROTECTION.

CRATE

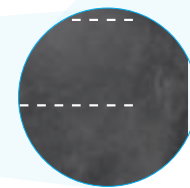

PROTECTIVE WAX LINES BETWEEN EACH SLAB.

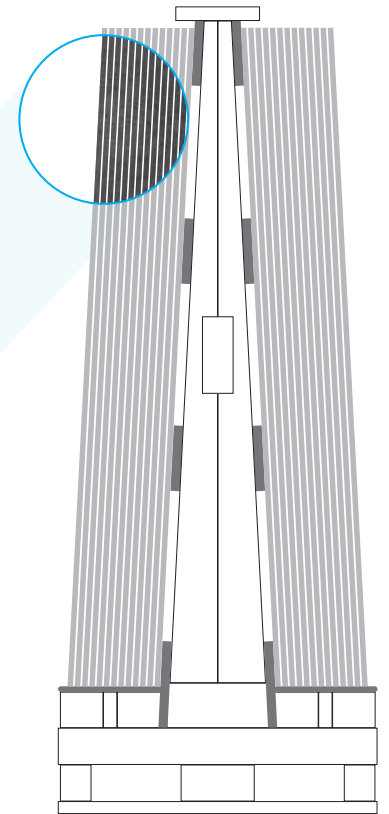

A-FRAME

CRATE				
THICKNESS	KG / SLAB	SLABS / CRATE	SQM / CRATE	KG / CRATE
6,5 mm / 0.25"	77	15	76,80	1.275
12 mm / 0.47"	152	9 (Lev./Honed) 10 (Matt)	46,08 (Lev./Honed) 51,20 (Matt)	1.488 (Lev./Honed) 1.640 (Matt)
2 cm / 0.78"	255	5	25,60	1.395

A-FRAME			
SLABS / A-FRAME	SQM / A-FRAME	KG / WOOD A-FRAME	KG / METAL A-FRAME
50	256,00	4.090	3.980
24	122,88	3.888	3.778
14	71,68	3.810	3.700

## HANDLING AND RECOMMENDED TOOLS ON SITE

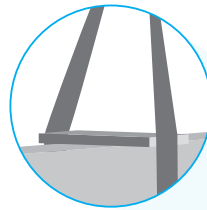
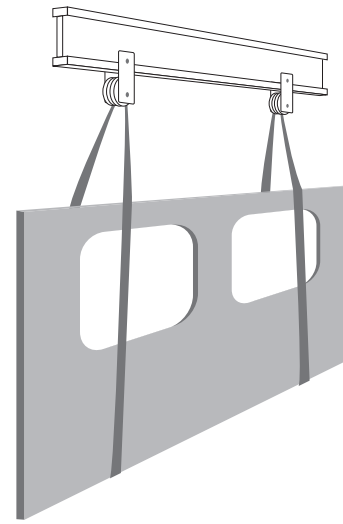
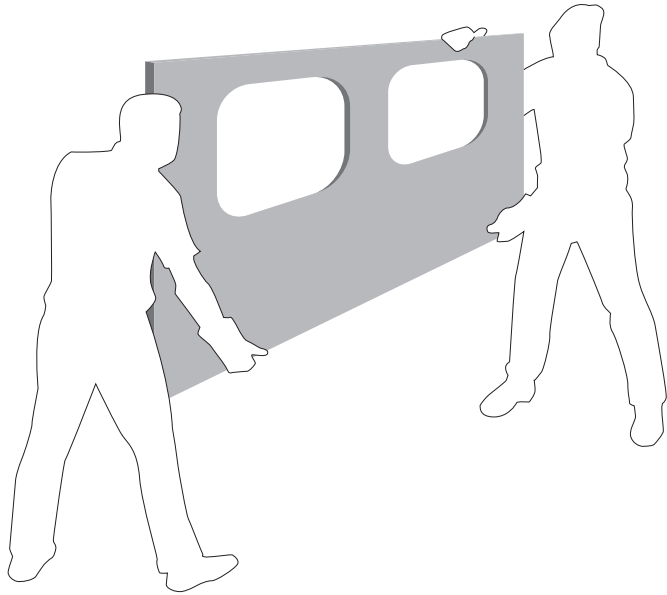
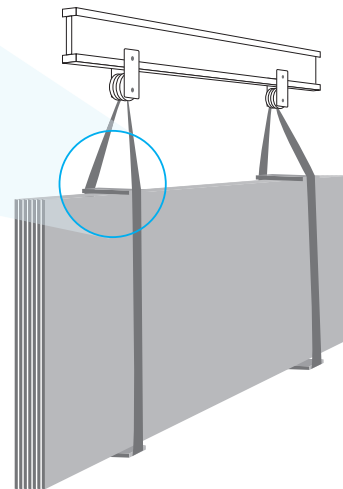
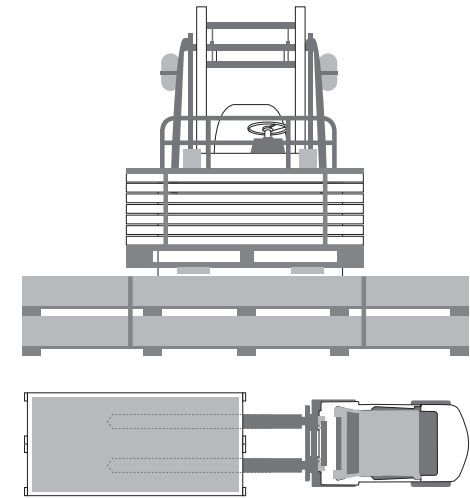

FIGURE 2



Cases (or stands) must be lifted from the long side by placing 2.5 m long forks under them. Slabs must be vertically handled and, in case of bridges, the slinging must be made using hemp cloth (steel chains are not recommended) to prevent any breakage and/or chipping. In case of storage on metal stands, the latter should be coated (wood or rubber).

For multiple grabs, the use of a lifting beam is advised, with canvas straps spaced out on the base and on the top by a wooden spacer slightly longer than the slab pack (as shown in figure 2). In this way the tension generated during handling is not applied to the slabs, avoiding the breakage of the material. Warning: always check the maximum load.



NON SOVRAPPORRE MAI VOLUMI DIVERSI, PER EVITARE ROTTURE  
TO AVOID BREAKAGE, NEVER STACK DIFFERENT VOLUMES



Use of the aluminium kits specially designed for the slabs is recommended for handling. The kits, with suckers, limit torsion and permit transport (always vertical) both manually and on forklift. 4 people are required for manual handling, handling vertically from the long side.

# CLEANING, MAINTENANCE AND CARE

## DAILY CLEANING

For daily cleaning, warm water and possibly a household detergent are recommended. Wipe clean with a damp cloth soaked in regular detergent and water. To avoid polished surface from scratching when cleaning, only use cloth made of soft fibers, suitable for cleaning of glass, kitchen appliance.

The following are recommended for heavier dirt:

- Acid: acid detergents, de-fouling cleaners, cement remover e.g. Viakal
- Alkali: basic, ammonia, degreasing detergent e.g. Chante Clair, Cif
- Solvent: universal solvent, thinner, turpentine, white spirit, alcohol
- Oxidant: bleach, hydrogen peroxide

After use, always rinse well with plenty of water.

## GUIDE TO REPAIR

Very small chipping can be repaired. Expert hands can restore very small chipping with epoxy resins, even though it is not easy to find the right tones and restore the original surface. Once the chipping is repaired, remove the excess resin with a cloth soaked in acetone before it hardens. Once it has hardened, work the resin by hand to make the surface uniform.

## GUIDE TO REMOVE WATERMARK

When water contains significant amounts of dissolved calcium, magnesium, or other minerals, hard water can be remained on countertops. When these minerals mix with soap, a chemical reaction occurs, leaving behind filmy soap scum. Over time, deposits can turn into a scaly mineral buildup on surfaces and dulls the shiny countertops.

Homeowners need to follow up with a rinse to remove any traces of soap scum that could dull the surface. After wiping, they also need to dry the surface. Standing water can leave mineral deposits behind that are hard to remove, so wipe up spills immediately and dry the surface with a microfiber cloth to soak up all the water.

## Detergents for the different types of Dirt

TYPE OF DIRT	TYPE OF DETERGENT
Beer, wine, coffee	Sodium hypochlorite (bleach) in solution or alkaline detergent
Ice cream	Sodium hypochlorite (bleach) in diluted solution
Tyre rubber	Organic solvent (trichloroethylene)
Greases and oil	Alkali-based detergent
Inks	Sodium hypochlorite (bleach) in solution or alkaline detergent
Indelible felt-tip pen	Organic solvent (trichloroethylene acetone)
Resins	Organic solvent (turpentine, white spirit, thinner)
Lines from aluminium	Acid detergent or abrasive cream/powder detergent
Rust	Acid-based detergent
Fruit juices	Sodium hypochlorite (bleach) in diluted solution
Other stains	Abrasive cream detergent





**The Leading Sintered Stone Supplier.**

**We serve customers with the best workmanship of Fabrication & Installation.**



 33 Ubi Avenue 3, # 07- 17, Tower B,  
Vertex, Singapore 408868

 Tel : 66590782

 info@nuovocorso.sg

 www.nuovocorso.sg

---

GST Reg No. : 201319930H



PREMIUM SINTERED  
STONE MANUFACTURER